

TACIT 
ALWAYS ON COURSE

GOLF COURSE EQUIPMENT

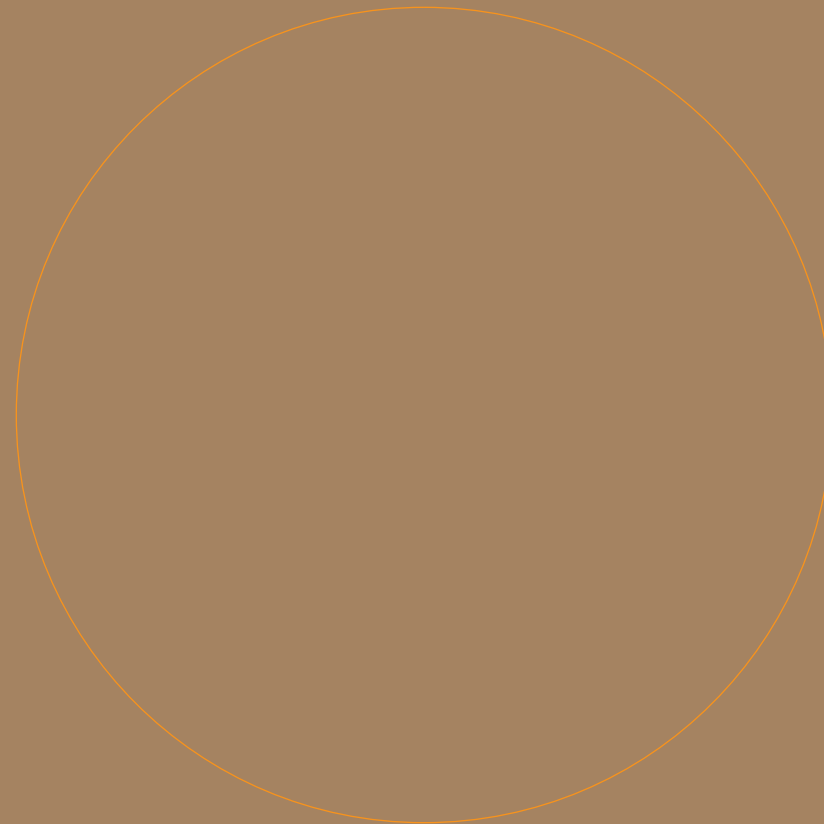

This hole was
precision cut
using a modified
version of the Tacit
**Shole Hammer
Holecutter**



“Golf is not, on the whole, a game for realists. By its exactitudes of measurements it invites the attention of perfectionists”

Heywood Hale Broun
Sports Writer





FOREWORD

Tacit is a family owned and run business. Our key activities are invested in the design, UK manufacture and worldwide distribution of bespoke golf course equipment.

Tacit's unique vision is to be a growing, caring organisation, striving to achieve better results year-on-year. We achieve this by blending investment programmes in all business activities, using modern equipment and systems with dedicated, experienced and skilled people in all areas.

My vision is to be universally recognised as the market leader in the management and execution of all our activities by using:-

- Our unique balance of commercial and technical expertise
- Our proven track record of excellent quality and service
- Our innovative delivery of value enhancing solutions to meet all our customers' needs

By working in partnership with superintendents and suppliers, we will continue to achieve world-class leadership in quality, engineering, design, delivery, service and management of all products.

We look forward to helping you become the best you can be.

Richard Webb
Chairman



59 Moat Farm Drive
Hillmorton
Rugby
Warwickshire
CV21 4HQ
England

www.tacitgolf.com

Email: sales@tacitgolf.com

TEL: +44 (0)1788 568818

FAX: +44 (0)1788 537485



“The golf course is furnished throughout with bespoke Tacit golf course equipment in reflection of the supreme, unsurpassed standards and quality that our members have come to expect over many years”

Brett Cox, Course Manager
Welwyn Garden City Golf Club

FRONT 9

PAGES 04 - 21

Ball Scoop
Ball Washer
Ball Washer Post
Ball Washer Replacement Part
Bell
Club Emblem Flags
Clubhouse Score Board
Corporate Flags
Corporate Tee Markers Bespoke
Distance Marker Discs
Distance Marker Posts
Divot Box
Event Board
Fairway Indicator Posts
Hazard Posts
Information & Etiquette Signs
Lifebuoy Ring
Litter Baskets
Log Tee Sign System
Personalised & Events Flags
Pin Placement Flags
Rake Decal
Replacement Brush Sets
Sparrow Rake
Standeasy Rake
Klaxon
Tee Marker - Aluminium
Tee Marker - Augusta Tee Marker
Tee Marker - Tufftex
U-Boot Shoe Cleaner
U-Boot Shoe Cleaner Tee Unit
Ultra Bin S1
Ultra Bin S2
Tee Marker - Woodland

17 Anti-Wear Ferrule - USA
12 Extreme Flagsticks
12 Green Keepers Bucket
13 Harlequin Flags
17 Holecutter Blades
20 Hole Cutting Board
08 Hole Cutting Tools
20 Holecup Inserts
06 Holecup Lifters
16 Holecups
16 Javelin Flagsticks - Tournament
14 Red Top Flagsticks
08 Tie-on Flags
16 Tour Flagsticks
16 Tube Flags
08 USA Specification Flagsticks
17 Velcro Flags
10 Winter Ferrule
07 Winter Holecup
20 Winter Holecutter
25
18
18
19
17
06
07
06
11
11
10
10
07

MIDDLE 9

PAGES 22 - 39

BACK 9

PAGES 40 - 57

29 Barrier Hoop
31 Barrier Hoop Signs
38 Bunker Stone Rake
25 Car Parking Signs
36 Chain
39 Dew Brushes
38 Drag Mat
34 Fence Posts - Fencing
38 Golf Course Signs
34 Green Speed Meter
30 Ground Socket System
31 Lawn Levellers
24 Line Marker Paint - Turf Paint
28 Maintenance Rake
24 Open Corer
29 Putting Markers
24 Roller Squeegee
28 Rope
34 Signs - Special & Corporate
36 Soil Profiler
Sprinkler Head Trimmer
Switch
Traffic Control Stakes



50
53
40
55
50
47
43
50
54
49
50
43
51
41
42
48
46
51
55
42
42
46
50

SHOLE HAMMER HOLECUTTER**NEW**

“Myself and the team have been using the Shole Hole Cutter at St Andrews Links for a couple of years now and have found it to be very reliable as well as user friendly. The Shole has become an important part of my team’s daily equipment and is my first choice for hole cutting at the Old Course”

Gordon McKie, Course Manager
Old Course St Andrews Links

SEE PAGE 33

FRONT 9
PAGES 04 - 21

MIDDLE 9
PAGES 22 - 39

BACK 9
PAGES 40 - 57

NEW PRODUCTS
PAGES 04 - 05



01

LOGO FLAGS
PAGES 22 - 23



10

MAINTENANCE RAKES
PAGES 40 - 41



19

TEE MARKERS
PAGES 06 - 07



02

STANDARD FLAGS
PAGES 24 - 25



11

FINE TURF TOOLS
PAGES 42 - 43



20

TEE AREA
PAGES 08 - 09



03

FLORIDA KEYS & WINTER FLAG CLIPS
PAGES 26 - 27



12

FINE TURF TOOLS
PAGES 44 - 45



21

BINS / BRUSHES
PAGES 10 - 11



04

STANDARD PINS
PAGES 28 - 29



13

DEW REMOVAL
PAGES 46 - 47



22

BALL WASHERS
PAGES 12 - 13



05

PINS
PAGES 30 - 31



14

PUTTING GREEN
PAGES 48 - 49



23

DIVOT / PITCH REPAIR
PAGES 14 - 15



06

HOLE CUPS
PAGES 32 - 33



15

TRAFFIC CONTROL
PAGES 50 - 51



24

FAIRWAY INFO / SAFETY
PAGES 16 - 17



07

HOLE CUPS
PAGES 34 - 35



16

SIGNS
PAGES 52 - 53



25

PLAYERS RAKES
PAGES 18 - 19



08

HOLECUTTING
PAGES 36 - 37



17

SIGNS
PAGES 54 - 55



26

LOGO FLAGS
PAGES 20 - 21



09

HOLECUTTING
PAGES 38 - 39



18

ORDER PLANNER
PAGES 56 - 57



27

**SOLE HAMMER
HOLECUTTER**
1013BCOM



SEE PAGE 36

REJUVENATOR
6040



SEE PAGE 44

REJOINDER
0919J



SEE PAGE 44

Example of the
Rejoinder pattern

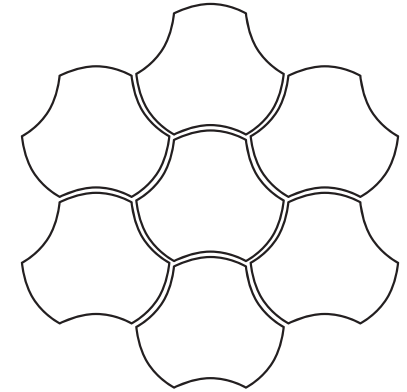

NANO GAUGE
0925NANO

SEE PAGE 39



FLORIDA KEY
0898FK

SEE PAGE 26



WINTER FLAG CLIP
0898FS

SEE PAGE 27



NEW PRODUCTS

SHOLE HAMMER HOLECUTTER

The Tacit Shole Holecutter cuts an exact 108mm hole every time with an integral hammer action. With an upright operation, it is easy on the back with a unique effortless core extraction system and the whole unit weighs less than 10kg! The bullseye spirit level makes sure every hole is cut level. It also comes with easy interchangeable compression / non-compression blades with an optional adjustable depth gauge.

REJUVENATOR

Restores ball marks, animal tracks and indentations in the green to the original putting surface level. No tamping needed, tailored for effective ergonomic use. Virtually no maintenance as stainless steel tines give your green the perfect finish.

REJOINER

Unique interlocking turf repair tool that allows damaged turf on the green to be repaired quickly and easily. The distinctive shape encourages the turf to knit in much quicker than other straight sided designs.

FLORIDA KEY

An ingenious way of rapidly changing the flag without the hassle of fiddly nuts; saves time and has no moving parts and hence nothing to break. Also screws on to an existing top ferrule.

The Florida key will reposition itself automatically in the wind yet requires just two twists to / remove.

WINTER FLAG CLIP

A simple but effective way of shortening the length of the flag therefore reducing wear on the flag, making the flag pin easier to handle in windy conditions.

NANO GAUGE

Competition tested, this Nano gauge sets the hole and cup instantly to R & A recommended size and depth. Its size allows it to be easily carried in a pocket for instant use, even while the competition is in play.

1013BCOM

6040

0919J

0898FK

0898FS

0925NANO

01

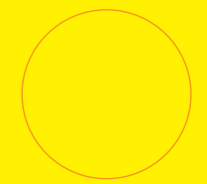

“The Rejoinder is great and easy to use. The shape is especially useful as it locks all edges”

Jon Allen, Course Manager
Northampton Golf Club

PEAR SHAPED TEE MARKERS



TUFFTEX TEE MARKERS



BESPOKE TEE MARKERS

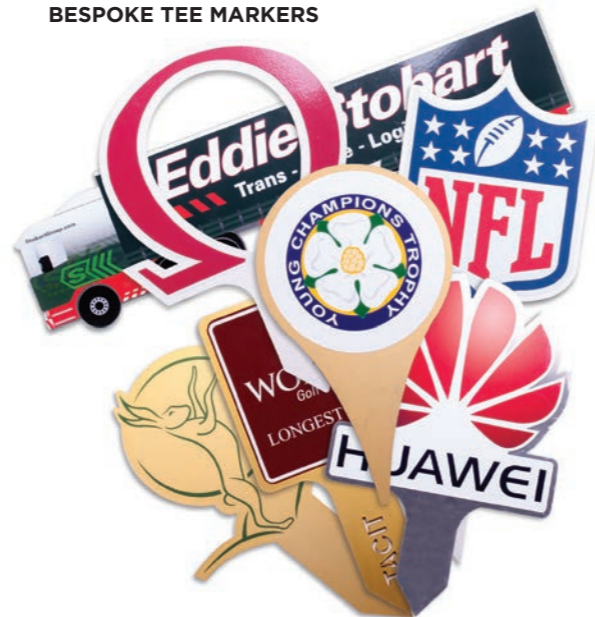

TUFFTEX TRADITIONAL TEE MARKERS

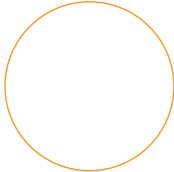

WOODLAND TEE MARKERS

0021L



0022L



0023L



0024N



BROKEN TEE CADDY

1071W



1071Y



1071R



1071G



AUGUSTA LOG TEE MARKERS

0016C



0016C



0016G



TEE MARKERS

TUFFTEX TEE MARKERS

Great value and performance in one; Tacit's Tufftex Tee Markers offer a durable and vandal resistant marker at an exceptional price. Tacit Tufftex's come complete with a stainless steel spike and are made to withstand tough treatment. To further frustrate the vandals, Tacit Tufftex's also float.

TUFFTEX TRADITIONAL TEE MARKERS

Providing the same value for money as the Tufftex Tee Marker and with the same rugged construction, the "Traditional" has the added bonus of being able to be customised either with a number, corporate or club logo.

BESPOKE TEE MARKERS

Can be manufactured to any 2D design, are laser cut to shape and then decaled to provide intricate detail as required. The design is only limited by your imagination. Let our Graphics department help you create a lasting impression on every tee.

PEAR SHAPED TEE MARKERS

Traditionally shaped, colour impregnated markers that are almost indestructible. Stainless steel spike means these markers will last indefinitely. The tee marker floats and is also instilled with UV stabiliser to inhibit the sun rays and keep the marker brighter for longer.

BROKEN TEE CADDY

For the more discerning golf course; a Tee Marker with a colour impregnated top combined to make a subtle but visible impression. Made from polypropylene with a stainless steel spike, these markers can withstand the harshest conditions.

WOODLAND TEE MARKER 75

An economical version of the Augusta, this Woodland Tee Marker is perfectly suited to parkland environments. Made with a stainless steel spike, these markers add class to any course. Corporate images are easily applied thanks to Tacit's unique interchangeable face plate and all at an affordable price.

AUGUSTA LOG TEE MARKER 75

A revolutionary slant on a traditional classic will add that touch of class to any tee. Made from recycled polymers, these wood effect logs never need to be painted, varnished or treated and will constantly look as good as the day they were purchased. Interchangeable end caps mean colours can be changed or refurbished in an instant and can be easily maintained. Whilst the decal system allows the corporate image to stretch throughout the course, the markers are held firmly in place by their stainless steel pins.

Tufftex Tee Marker White	0025
Tufftex Tee Marker Yellow	0026
Tufftex Tee Marker Red	0027
Tufftex Tee Marker Blue	0028
Tufftex Tee Marker Black	0008
Tufftex Tee Marker Green	0009

	PLAIN	LOGO	NO'S
Tufftex Traditional Tee Marker White	0025B	0025L	0025N
Tufftex Traditional Tee Marker Yellow	0026B	0026L	0026N
Tufftex Traditional Tee Marker Red	0027B	0027L	0027N
Tufftex Traditional Tee Marker Blue	0028B	0028L	0028N
Tufftex Traditional Tee Marker Black	0007	0007L	0007N
Tufftex Traditional Tee Marker Green	0006	0006L	0006N

Red	0030
Yellow	0031
White	0029
Blue	0032
Black	0011
Green	0012

	ALI	PLAST
White	1071W	1071WP
Yellow	1071Y	1071YP
Red	1071R	1071RP
Green	1071G	1071GP

	PLAIN	LOGO	NO'S
Woodland Tee Marker White	0021	0021L	0021N
Woodland Tee Marker Yellow	0022	0022L	0022N
Woodland Tee Marker Red	0023	0023L	0023N
Woodland Tee Marker Blue	0024	0024L	0024N
Woodland Tee Marker Chrome	0024C	0024CL	0024CN
Woodland Tee Marker Gold	0024G	0024GL	0024GN

	PLAIN	LOGO	NO'S
Augusta Tee Marker White	0013	0013L	0013N
Augusta Tee Marker Yellow	0014	0014L	0014N
Augusta Tee Marker Red	0015	0015L	0015N
Augusta Tee Marker Blue	0016	0016L	0016N
Augusta Tee Marker Chrome	0016C	0016CL	0016CN
Augusta Tee Marker Gold	0016G	0016GL	0016GN

“The longevity and quality finish of the Tacit Woodland Logoed Tee Markers give my tees the look my members demand”

Alec Macindoe, Course Manager
Newbury & Crookham Golf Club

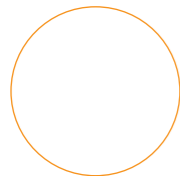

FREE STANDING CLOCK / INFORMATION BOARD

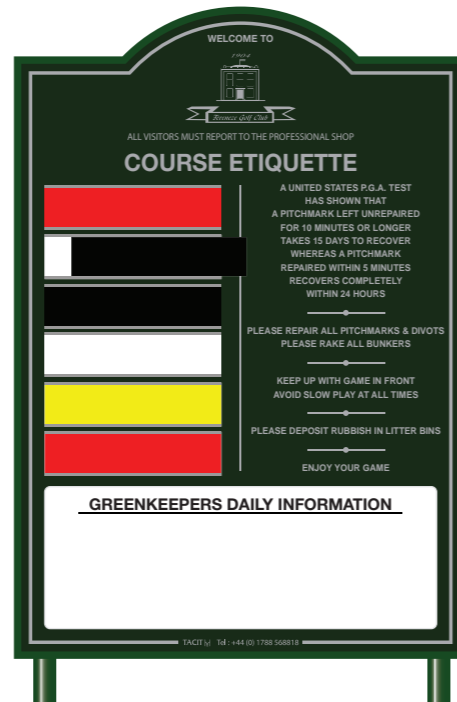

- COURSE CLOSED**
- BUGGIES ON**
- BUGGIES OFF**
- PREFERRED LIES**
- CHEMICALS APPLIED**
- TAKE CARE** SLIPPERY CONDITIONS ON COURSE
- WINTER GREENS IN PLAY
- FAIRWAYS. PLAY FROM NEAREST POINT IN SEMI ROUGH
- SPRAYING IN PROGRESS**

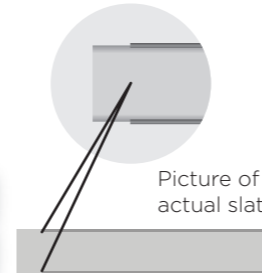

Choose the inserts you require for the display board, customised inserts can be created on request. All inserts can be double sided or one side with text and one side with dry wipe.

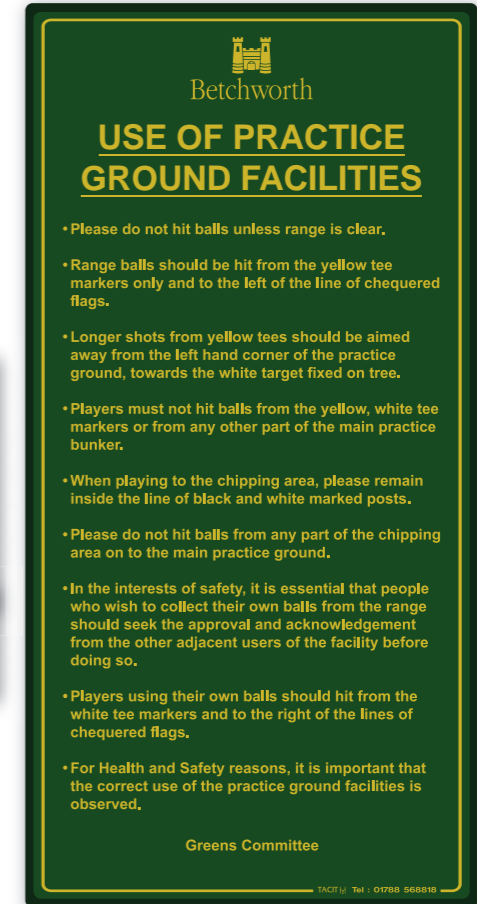

0059

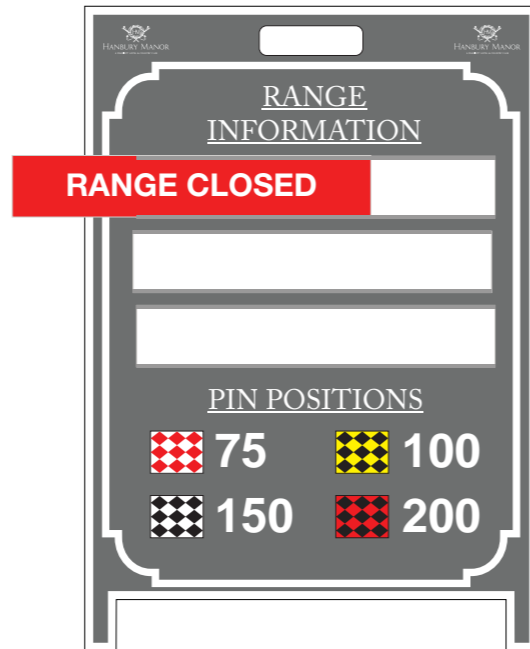
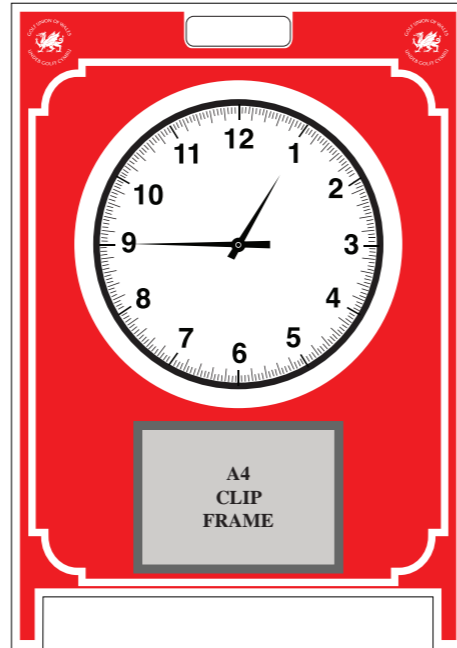

TEE AREA

TACIT EVENT BOARD

This is the definitive event board made from a high grade aluminium. It can be fixed to a wall or posts. Daily events are slotted into place whilst today notices can be conveniently written or removed on a dry wipe board. Our team of designers will include your club or corporate colours to create an event board that looks attractive both outside or in the clubhouse.

Any size or shape

POA

FREE STANDING CLOCK INFORMATION BOARD

Sandwich board construction allows this board to be placed on the practice ground or by the pro shop. The outdoor clock is impervious to rain and the dry wipe area underneath allows daily messages to be conveyed. The back of the sign can also be utilised to give course or sales information.

Free Standing Clock Information Board

0059

03

“The sign department produces consistent quality, which provides us with a high standard across the course”

Paul Sharp, Course Manager
Peterculter Golf Club Aberdeen

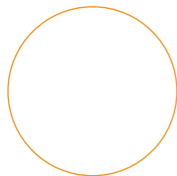

ULTRA BINS

S2
S2 0080



S1
S1 0062



LITTER BASKET
0065

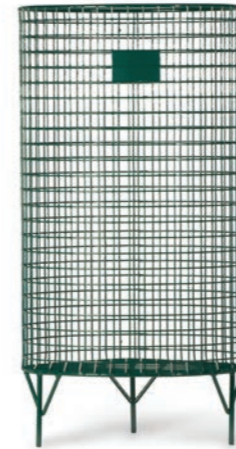

BALMORAL
1069



SANDRINGHAM
1070



BINS AND BRUSHES

TEE UNIT
0090



SET 3
0087

SET 6
0088

SET 9
0086



DEBRIS BRUSH
0089



SCRAPER
0085BS



U-BOOT SHOE CLEANER
0085



ULTRA BIN S1

The first of our Ultra Bin Series is the standard Ultra Bin, All the Ultra Bin Series feature a polyethylene body shell that will not rust or dent and incorporate a galvanised steel liner that is easy to remove and clean. The speckled green finish of the Ultra Bin Series blend seamlessly into your course environment. The S1 model has an open removable top and both models can be customised with text or course logos.

ULTRA BIN S2

This latest addition to our Ultra Bin Series carries all the standard features, but has a 22% larger capacity than the Ultra Bin S1 and features a locking lid. The Ultra Bin S2 is ideal for windy spots and heavy traffic areas.

LITTER BASKET

Our entry level plastic coated wire litter basket is a light weight basket with a removable bottom tray for hygienic cleaning and emptying.

BALMORAL BIN

The Balmoral (Rhinowood) Bin gives a hardwood traditional finish to a golf course classic. Manufactured to exacting standards the bin is obviously built by time served craftsmen. With an easy to remove lid and a galvanised liner, rubbish collection becomes easy and efficient.

SANDRINGHAM BIN

A modern twist to the Balmoral Bin, similar looking but with recycled wood panelling around the outside of the unit making it a much more environmentally friendly bin finished again to Tacit's exacting standards.

U-BOOT SHOE CLEANER SERIES

Recent tests have shown the U-Boot Shoe Cleaner to be the number one choice for cleaning soft spikes. Its bristles being particularly suited to removing debris that prevents the correct function of soft spikes. The slatted design of the U-Boot Shoe Cleaner allows debris to fall away from the brushes, while the positioning of the brushes cleans both the soles and sides of your shoes simultaneously. The U-Boot Shoe Cleaner allows the user to lean on a handrail while brushing shoes.

SCRAPER

A great addition to the u boot shoe cleaner, the scraper allows ingrained mud to be moved from the bottom of golf shoes with ease.

TEE UNIT

Our other style U-Boot Shoe Cleaner is the Tee Unit, its low profile means it is the perfect shoe cleaning unit that can be installed near a tee. It is low and unobtrusive to the eye and will blend effortlessly into the course.

DEBRIS BRUSH

A hardwood construction with a brass scraper gives your shoe cleaner that added class.

Ultra Bin S1 42ltr - 740mm x 390mm
Ultra Bin S1 + Logo

0062
0063

Ultra Bin S2 90ltr - 1130mm x 500mm
Ultra Bin S2 + Logo

0080
0081

Round Litter Basket (green only)
Removable Tray

0065
0066

Balmoral Bin

1069

Sandringham Bin

1070

U-Boot Shoe Cleaner with handrail
Replacement Brush Set - Complete Set (3 brushes)
Replacement Brush Set - Side Set (6 brushes)
Replacement Brush Set - Complete Set (9 brushes)

0085
0087
0088
0086

U-Boot Shoe Cleaner Tee Unit

0090

Long Handle Debris Brush

0089

“Tacit provide quality products and back these products up with exceptional services”

Sean Whipp, Course Manager
Royal Wimbledon Golf Club

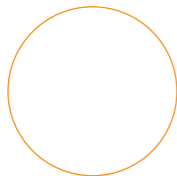

3010G



3010B



3010R



3010GL

MOUNTING PIPE
3022



3020



BIN
3036

TOWEL
0078G



LOGO TOWEL
0078BL



WHITE POLYETHYLENE
GASKET
3027



COVER SCREWS
3028

DRAIN PLUG
3030

3025



3026



BALL WASHERS



ECONOMY BALL WASHER
0070

MOVE CONCENTRATED GOLF BALL CLEANER
0084M

CLASSIC BALL WASHER

Tacit's traditional classic that lives up to our reputation for quality, longevity and ease of use. Investment cast aluminium body with an epoxy powder coating. All fittings are marine stainless steel. The spiral action plunger adds traditional values whilst the replacement plunger knob and large tamper resistant drain plug allow for ease of maintenance.

CLASSIC BALL WASHER PARTS

CLASSIC BALL WASHER PARTS

REPLACEMENT PARTS

A complete range of spare parts are available for the Tacit Economy Ball Washer system.

ECONOMY BALL WASHER

A ball washer that combines quality and reliability at an affordable price. Made from super tough polypropylene; the case stays practically maintenance free whilst a large sump and drain plug allows for easy washouts. All internal parts are impervious to water (no wooden brushes to rot and smell!) and can be replaced in seconds. A ball washer that cleans golf balls better than ball washers that cost twice the price.

MOVE CONCENTRATED GOLF BALL CLEANER

Move is a sequoia pine fragranced biodegradable golf ball washer liquid conveniently bottled in handy 1 litre bottles.

- Highly concentrated
- Fragrant
- Moves mud with ease

Classic Ball Washer Tacit Green
Classic Ball Washer Birdie Black
Classic Ball Washer Par Red
Classic Ball Washer Tacit Green with Logo

LOGO
3010GL
3010BL
3010RL
3010GL

Towel Green
Towel Blue with Logo
Agitator Assembly
Brush Assembly
White Gasket
Cover Screws
Drain Plug
Drain Plug Gasket
Ball Washer Towel Hooks
Ball Washer Litter Bin 4 kilos / 32 litres (including brackets)

0078G
0078BL
3025
3026
3027
3028
3030
3032
3035
3036

Mounting Pipe 34"
Mounting Pipe 46"

3020
3022

Base Tacit Green
Base Tacit Black
Base Tacit Red

3015G
3015B
3015R

Brass Drain Plug
Paddle Assembly
Brushes (pair)
Towel Green
Towel Green with Logo
Towel Blue
Towel Blue with Logo
Towel Clip

0076
0074
0075
0078G
0078GL
0078B
0078BL
0079

Economy Ball Washer
Ball Washer Post

0070
0071

0084M

“The Tacit Classic Powder Coated Ballwasher is a very strong ballwasher, nicely presented with a logo, golfers like them and greenkeepers find them easy to clean”

Martin Browne, Course Superintendent
Skerries Golf Club

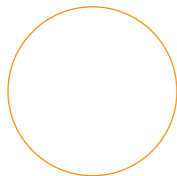

REJUVENATOR
6040



DIVOT BOX SPECKLED
0061



DIVOT BOX GREEN
0060



SCOOP
0064



DIVOT BOX LOGO
0053



LOGO DIVOT BAGS
4970LOGO



DIVOT BAG TREE
0178



0179

0179S



DIVOT / PITCH REPAIR

REJUVENATOR

Restores ball marks, animal tracks and indentations in the green to the original putting surface level. No tamping needed, tailored for effective ergonomic use. Virtually no maintenance, stainless steel tines give your green the perfect finish.

DIVOT BOX

Tacit's Divot Box promotes instant repair on the tee by providing the materials required to easily fill and repair divots. Moulded from super tough polyethylene and designed with a lid to prevent water from entering, the Tacit Divot Box is unquestionably superior to any other divot box on the market. The box has an 18ltr capacity and can be sighted at ground level or on a stand, combined with the ability to attach a sponsor plate to the lid this truly is the ideal companion to any tee.

Other colours available on request.

DIVOT BAG TREE

The ideal way to get members involved in course maintenance. Placed at the beginning of the hole and regularly rotated to cover all 18 holes the members can easily divot fill one hole at a time without having the inconvenience of carrying sand and seed for 18 holes. A proven course improver and money saver.

LOGO DIVOT BAG

Add a touch of class and security by putting your club logo on the divot bag. Any wording or logo can be applied and can even be individually numbered.

Rejuvenator

6040

Divot Box Forest Green
Divot Box Green Speckled
Divot Box Forest Green with Logo
Divot Box Green Speckled with Logo
Divot Scoop

0060
0061
0053DG
0053
0064

Divot Bag Tree
Bags
Sign

0178
0179
0179S

Logo Divot

4970LOGO

06

“The Rejuvenator works well all year, on anything from pitchmarks to deer damage”

Martin Scothern, Green Superintendent
Woolaton Park

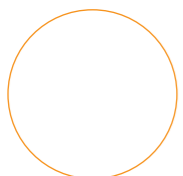

FAIRWAY INDICATOR POSTS
Tacit's 3m Fairway Indicator Posts are available in black and white stripe or red and white stripe and made with an extra thick wall diameter to resist ball impact whilst staying light enough for members to remove them prior to playing their shot. Tacit's Fairway Indicator Posts are provided with a ground socket to make installation and replacement easy whilst also ensuring the post remains upright at all times.

RECYCLED GROUND SOCKET LUMBER HAZARD POSTS
Made from self coloured reconstituted plastic; these hazard posts will never need painting or refurbishing. Simply speaking they will last a lifetime and you're helping the environment!

RECYCLED GROUND SOCKET DISTANCE MARKER POSTS

RECYCLED SPIKED LUMBER HAZARD POSTS
Self coloured reconstituted plastic with an integral stainless steel spike means these hazard posts will never need painting or refurbishing. Simply speaking they will last a lifetime and you're helping the environment!

RECYCLED SPIKED DISTANCE MARKER POSTS

ALUMINIUM CAST DISTANCE MARKER DISCS
A perfect low profile Distance Marker Disc. When fitted it provides an extremely visible reference for the various distances.

All colour and number variation options available.

GROUND SOCKET SYSTEM
By using Tacit's Ground Socket System you save time and money by eliminating the need to dig holes and mix concrete. Simply drive the ground socket into the turf with Tacit's solid steel ground socket tool to leave the socket flush with the soil.

FAIRWAY INFO / SAFETY



KLAXON HORN
0091



BALL SCOOP
0091



6" BELL
0174



9" BELL
0175

Bracket
0176

Lanyard
0177



LIFE BUOY RING
0170



FLOATING ROPE
0171

RECYCLED LUMBER HAZARD POSTS

Out Of Bounds
Lateral Water Hazard
Water Hazard
Green

DISTANCE MARKER POSTS

Blue Post
Green Post
Blue Spiked Post
Green Spiked Post

Ground Socket Tool - Rectangular
Ground Socket - Rectangular

DISTANCE MARKER DISCS

White Distance Marker Disc
Yellow Distance Marker Disc
Blue Distance Marker Disc
Red Distance Marker Disc

KLAXON HORN SYSTEM

Simple and easy to install, this cost effective air horn gives immediate and effective warning. Used for warning players of potential lightning strikes. Audible over the entire course in most situations. No power supply required.

BALL SCOOP

A 3m reach and lightweight aluminium shaft allows the scoop to be used easily by all your members and greenstaff alike. With a cast aluminium head and basket, the collection of balls becomes easy.

BELL AND BRACKET

Tacit's Bells and Brackets are cast at a foundry specialising in the production of high quality bespoke bells. Only the finest high grade bronze is used to provide a bell of superior shape and tone.

LIFE BUOY RING AND ROPE

Tacit's Life Buoy conforms to all recognised Health and Safety guidelines for use at inland open water sites. Ensure the people using your course are covered by the availability of a well marked and positioned life buoy and floating rope.

		SPIKE	NO SPIKE	
		0198	0198NS	
		0196	0196NS	
		0197	0197NS	
		0196G	0196GNS	
	100YDS		150YDS	200YDS
0196BNS-100	0196BNS-135	0196BNS-150	0196BNS-200	
0196GNS-100	0196GNS-135	0196GNS-150	0196GNS-200	
0196B-100	0196B-135	0196B-150	0196B-200	
0196G-100	0196G-135	0196G-150	0196G-200	
		0199T		
		0199		
	100YDS		150YDS	200YDS
0205/100		0205/150	0205/200	
0206/100		0206/150	0206/200	
0207/100		0207/150	0207/200	
0208/100		0208/150	0208/200	

30m Nylon Tube & Clips
Regulator
Push Button Control
Horn & Adapters
Full System

0092
0093
0094
0094A
0091

Ball Scoop-Complete
Ball Scoop-Head only

0180
0181

6" Bronze Bell Small Complete
9" Bronze Bell only
9" Mounting Bracket
Lanyard

0174
0175
0176
0177

Life Buoy Ring
30mm Floating Orange Safety
Rope

0170
0171

“A first class product and service. Excellent attention to detail and leadtimes”

Stuart Donald, Course Manager
Knebworth Golf course



0133



0132



0134

SPARROW RAKE



RAKE DECALS

0130



0131

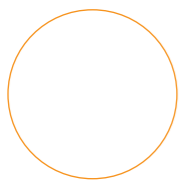

PLAYERS RAKES



STAND EASY RAKE

STAND FOR ACCUFORM RAKE

6037STAND



0147



0148



0146



SPARROW BUNKER RAKES

Undoubtedly, the finest players' bunker rake on the market. Available in 3 colours; white, green or black and fitted as standard with a plastic coated aluminium shaft. The Sparrow Rake is at home either in or out of the bunker.

SPARROW BUNKER RAKE GRIP

RAKE DECAL

A simple reminder to place rakes in or out of the bunker.

STANDEASY RAKE

Combining Tacit's Sparrow Rake with a stand helps keep the handle dry. Tacit have consistently provided top class golf clubs with a rake to match their members' exacting standards. Available in white, green or black.

STAND FOR ACCUFORM RAKE

	COMPLETE	HEAD	SHAFT
White Rake	0132	0135	0138
Green Rake	0133	0136	0139
Black Rake	0134	0137	0140

0156

In the bunker	0130
Outside of the bunker	0131

Green Rake	0146
Black Rake	0147
White Rake	0148
Stand only	0155
Grip only	0156

6037STAND

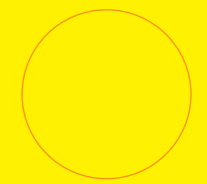

“The Standeasy was the original handle-off-the-ground players rake, that has proven its quality over time”

David Goodchild, head Greenkeeper
Ellesborough Golf Club

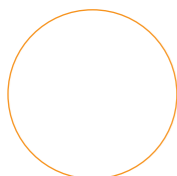

LOGO FLAGS

LOGO FLAGS

- Full colour matching
- Matching existing flags
- Embroidering available
- Quadruple stitched leading edge
- Variety of different fittings & materials
- Highest quality screen printing

CLUB HOUSE EMBLEM FLAGS

We are renowned throughout the UK and Europe for the craftsmanship and skill we put into the production of our Club House Emblem Flags. All Club House Flags are appliquéd both sides to give a perfect finish.

EMBROIDERED FLAGS

Wholly manufactured in Rugby, England by skilled operators, Tacit's embroidered flags need to be seen to be believed.

Using only the best embroidery thread available, it's combined with artwork that is specific to every shape or form, its no wonder that everyone is insisting their embroidered flags are made by Tacit.

0807

09

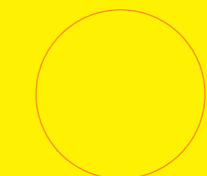

“ Tacit Logo Embroidered Flags are long lasting with excellent performance & presentation ”

Peter Hall, Course Manager
Whitcraigs Golf Club

EMBROIDERED FLAGS



SCREEN PRINTED FLAGS

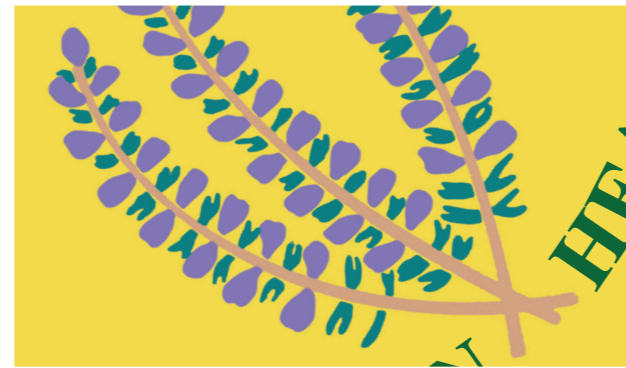

DIRECT PRINT FLAGS

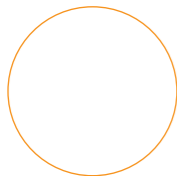

TYPES OF STITCHING

FOUR STITCHED LEADING EDGE



DOUBLE STITCHED LEADING EDGE



WINTER TEMPEST FLAG



0282WINY(F) 0282WINR(F) 0282WINW(F) 0282WINRB(F)

FITTINGS AND MATERIALS

TIE



TUBE



VELCRO



LOGO FLAGS

EMBROIDERED FLAGS

- Stitched logo on nylon flag
- Made in England
- Large eye-catching designs
- Double sided
- Readable on both sides
- Anti-fungal material
- Short turnaround times
- Superior quality

SCREEN PRINT

- Ink printed onto nylon
- Hand made in England
- Traditional method
- Ink is ingrained into the material
- Vibrant colours
- Sharp images
- Reads correctly from both sides
- Excellent for television events

DIRECT PRINT

- Ink printed by machine and heat cured onto knitted polyester
- Quick supply times
- Cheap
- Single or double sided
- Deal event flags
- Lightweight

LOGO FLAGS

- Full colour matching
- Matching existing flags
- Embroidering available
- Quadruple stitched leading edge
- Variety of different fittings & material
- Highest quality screen printing

WINTER TEMPEST FLAGS

- Especially for high wind courses
- Tempest material construction
- Lightweight material will pick up in all winds
- 13" / 330mm x 4" / 10mm
- Less stress on pins, cups and golfers wrists
- Material guaranteed for 2 years

“Simply the best logo flags on the market”

Peter Todd, Course Manager
The London Club

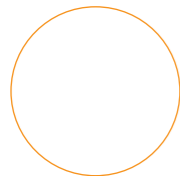

TACIT VELCRO & TIE-ON FLAGS

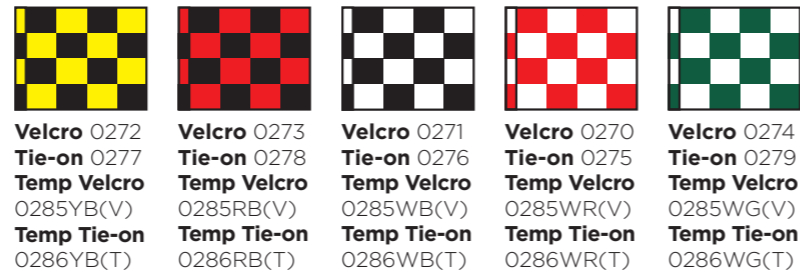
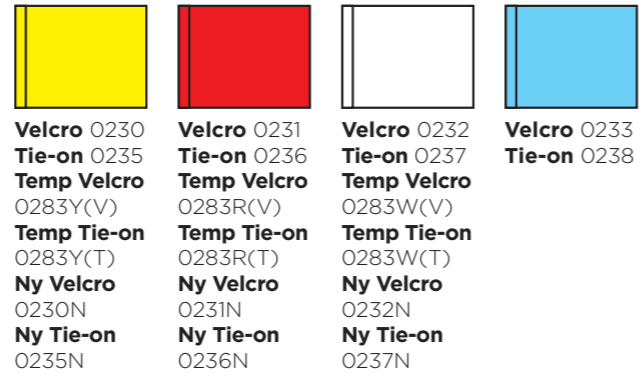
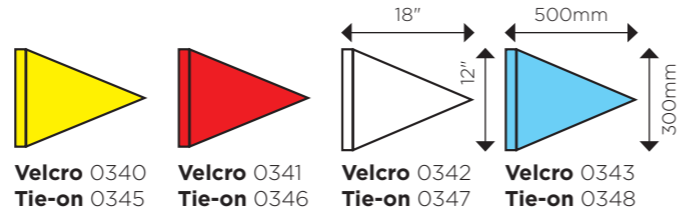

TUBE FLAGS

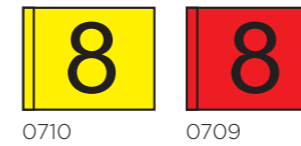
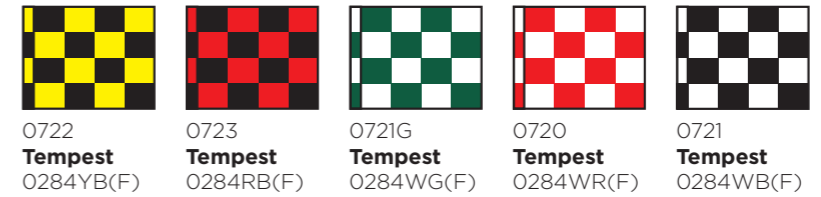
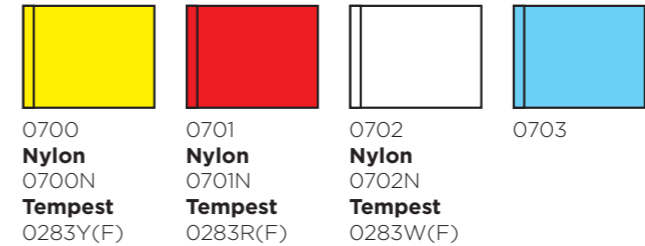
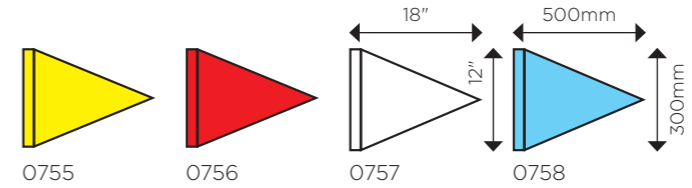

Nylon



Knitted Polyester



Tempest

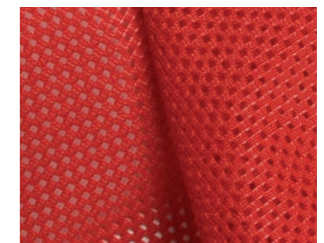

HARLEQUIN FLAGS



Tube 0730
Velcro 0290
Tie-on 0295
Tempest
 0287RY(F)
Temp Velcro
 0288RY(V)
Temp Tie-on
 0289RY(T)



Tube 0731
Velcro 0291
Tie-on 0296
Tempest
 0287YR(F)
Temp Velcro
 0288YR(V)
Temp Tie-on
 0289YR(T)

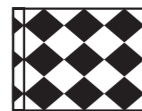

Tube 0732
Velcro 0292
Tie-on 0297
Tempest
 0287WB(F)
Temp Velcro
 0288WB(V)
Temp Tie-on
 0289WB(T)



Tube 0733
Velcro 0293
Tie-on 0298
Tempest
 0287YB(F)
Temp Velcro
 0288YB(V)
Temp Tie-on
 0289YB(T)

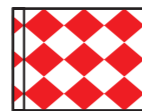

Tube 0734
Velcro 0294
Tie-on 0299
Tempest
 0287WR(F)
Temp Velcro
 0288WR(V)-
 Bracket
Temp Tie-on
 0289WR(T)

PIN PLACEMENT FLAGS



0360
Tournament
 0300Y



0361
Tournament
 0300R



0362
Tournament
 0300W



0363
Tournament
 0300SB



0365
Tournament
 0301Y



0366
Tournament
 0301R



0367
Tournament
 0301W



0368
Tournament
 0301SB

N.B. A nylon pin placement collar with thumb screw is available and designed for ease of use when positioning flag.

13mm Collar 0370
16mm Collar 0371
Tournament Collar 0374



STANDARD FLAGS

TACIT VELCRO & TIE-ON FLAGS

Tacit have the deserved reputation of producing the best flags in the business, made from high quality Nylon or Polyester and completed with Tacit's Signature 4 stitched leading edge to minimise fraying. Tacit's flags will outlast any other flags on the market. Try them and be prepared to be impressed.

TUBE FLAGS

The Tube Flag is now the standard for USGA Specification Flagsticks made from superior materials and incorporating Tacit's signature 4 stitched leading edge. Tacit's tube flag is the only one that comes with a flange stitched into the flag to give superior visibility and wear. The tube flag is easily held in place with Tacit's unique Turret nut which accepts tightening by hand, screwdriver or spanner.

TEMPEST FLAGS

Having scoured the textile world Tacit have found a material so durable we are willing to guarantee 12 months wear before the material breaks down. Combined with our reputation for the longevity of our stitching this flag has no equals.

No other company will guarantee their flags for 12 months - **WE DO!**

HARLEQUIN FLAGS

"Outstanding" is the only word to describe this latest Tacit innovation. Be the first to try the Tacit Harlequin Flags and let the others just fade away. Made to Tacit's usual exacting standards, double sided and available in a range of colours and fittings.

PIN PLACEMENT FLAGS

Made to Tacit's exacting standards and manufactured in a variety of colours, Tacit's Pin Placement Flags are available plain or with a request to repair pitchmarks.

N.B. A Nylon Pin Placement collar with thumb screw is available and designed for ease of use when positioning flag.

13mm Collar
 16mm Collar
 Tournament Collar

0370
0371
0374

“ Tacit’s range and quality has become both extensive and of a very professional standard. This alone makes it striking to both the course manager and the golfer ”

Gareth Roberts, Course Manager
Hackney Common Golf Club

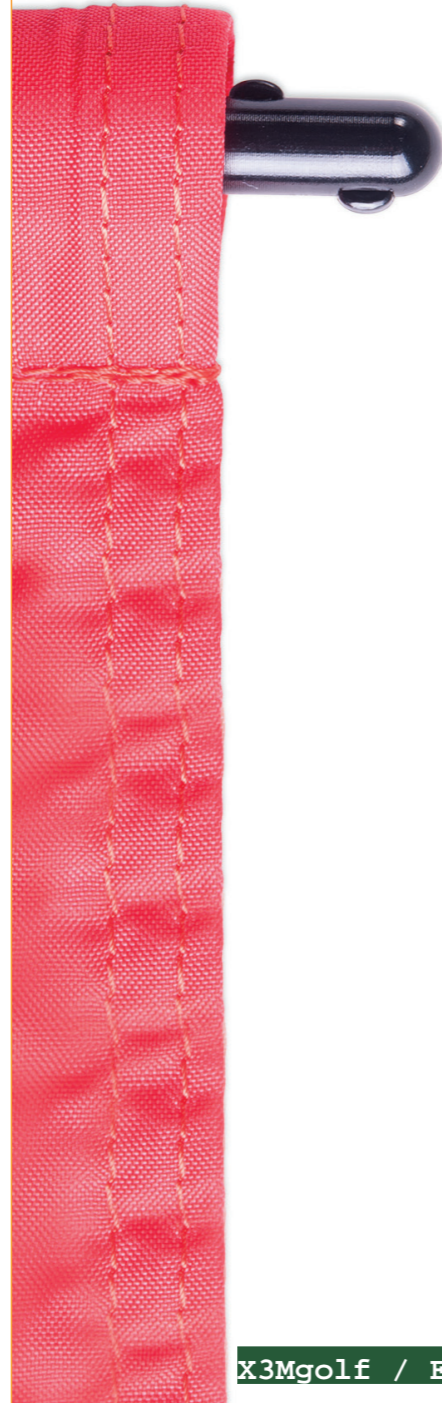

FLORIDA KEY

Tacit has finally solved the problem of lost or cross threaded nuts on the flag pins. With its unique key way design, the flag can easily be removed in seconds and replaces just as quickly. Clubs that run the 3 colour pin placement indicator system can quickly and easily change the flags, saving on average 4 minutes per flag change. If the holes are changed daily this equals 72 minutes a day, this is equivalent to the saving of 8 hours a week per week in labour 4 days a month or 48 days a year...

A top stud that has protruding nodes 180° opposed and staggered correspond to a notch in the flag tube so that when the tube is aligned the flag can be moved up one stage. If the flag is then rotated by 180° it can be moved over the second node and removed completely. Replacing the flag takes seconds by sliding the flag over the pin and giving two 180° twists the flag is back in place. If the flag should ride up in high winds it has to swivel another 180° to come off. Due to the set up of the key way the flag will usually return to its original position. The Florida Key is threaded to fit all existing top ferrules so acorn nuts or turret nuts become obsolete.

Because the Florida Key is solid and has no moving parts there is nothing to go wrong with the key; no slots for soil to get jammed in and no moving parts to break.

0895FK



FLORIDA KEY

1. Rotate

2. Lift

3. Rotate

4. Lift

5. Remove

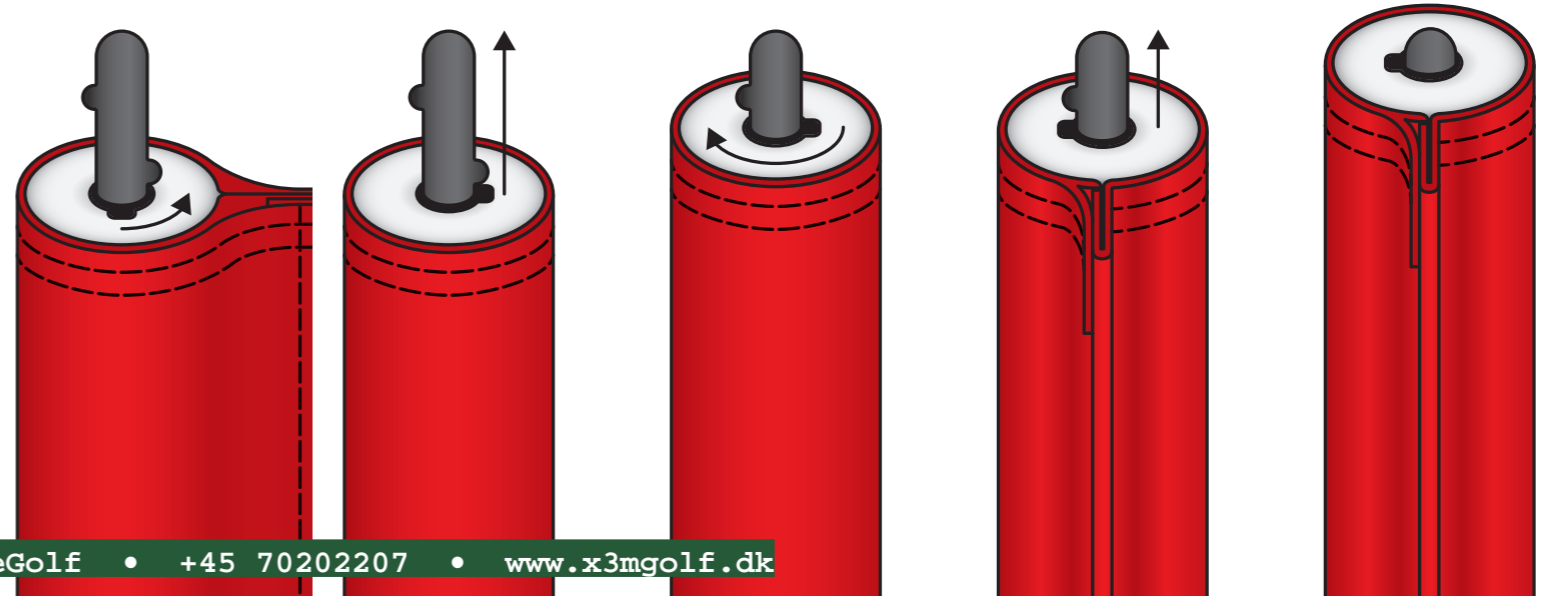

WINTER FLAG CLIP

The idea for Winter Flag Clips came as a direct result of listening to our customers. Mr J.J. Young - Course Manager at Tralee Golf Club used to put elastic bands on his flags to reduce their size in the severe windy weather in the winter on the west coast of Ireland to protect his golfers wrists and the course equipment.

We at Tacit took the idea and developed the Winter Flag Clip. By rolling the flag around the tube the flag can be shortened to the desired length and then held semi permanently in place. When the weather abates the clips can be removed in seconds and the flag instantly returned to its original length. Alternatively the flag can be shortened for the duration of the winter with the flag clips resulting in the lifespan of the flag being greatly extended.

0895FS

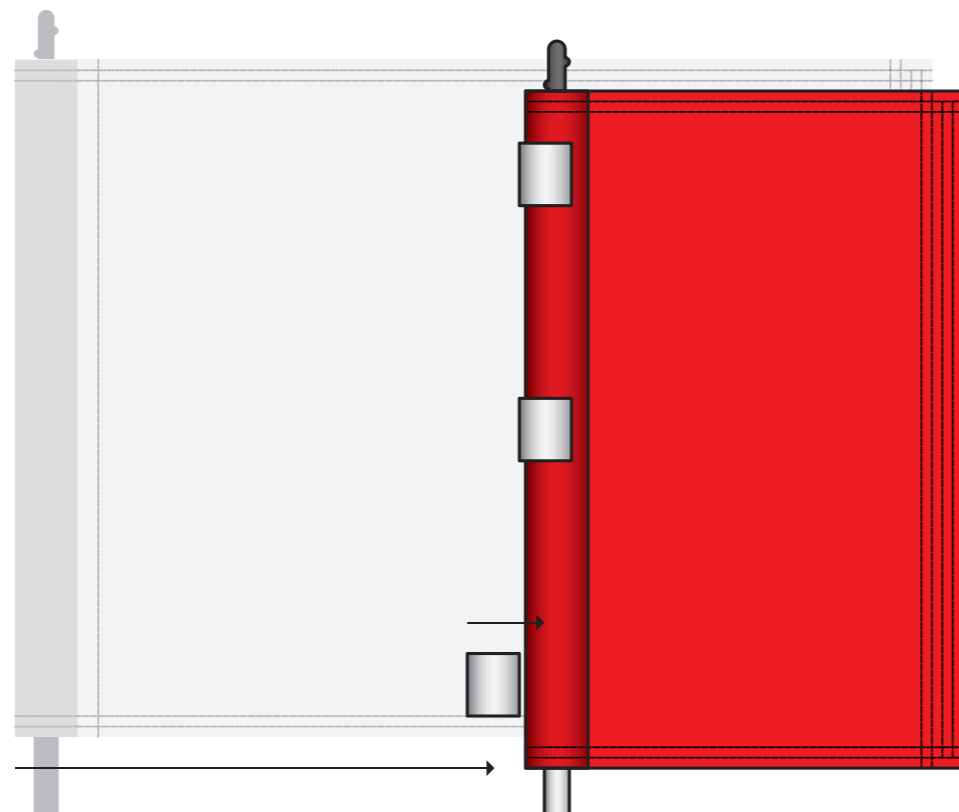

1. Roll flag to a third of its normal size.
2. Attach Winter Flag Clips to the rolled up flag tube.

FLORIDA KEYS & WINTER CLIPS

FLORIDA KEY

An ingenious way of rapidly changing the flag without the hassle of fiddly nuts. It saves time and has no moving parts and hence nothing to break. Also screws on to an existing top ferrule.

The florida key will reposition itself automatically in the wind yet requires just two twists to remove.

0895FK

WINTER FLAG CLIP

A simple but effective way of shortening the length of the flag, reducing wear and making the flag pin easier to handle in windy conditions.

0895FS

“Convenient and very easy to use; the Florida Key vastly speeds up the process of switching the flag on the flag stick when the three colour pin placement system is in operation”

John Doyle, Course Superintendent
Wexford Golf Club

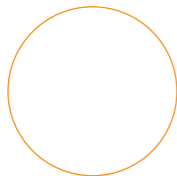

STANDARD PINS

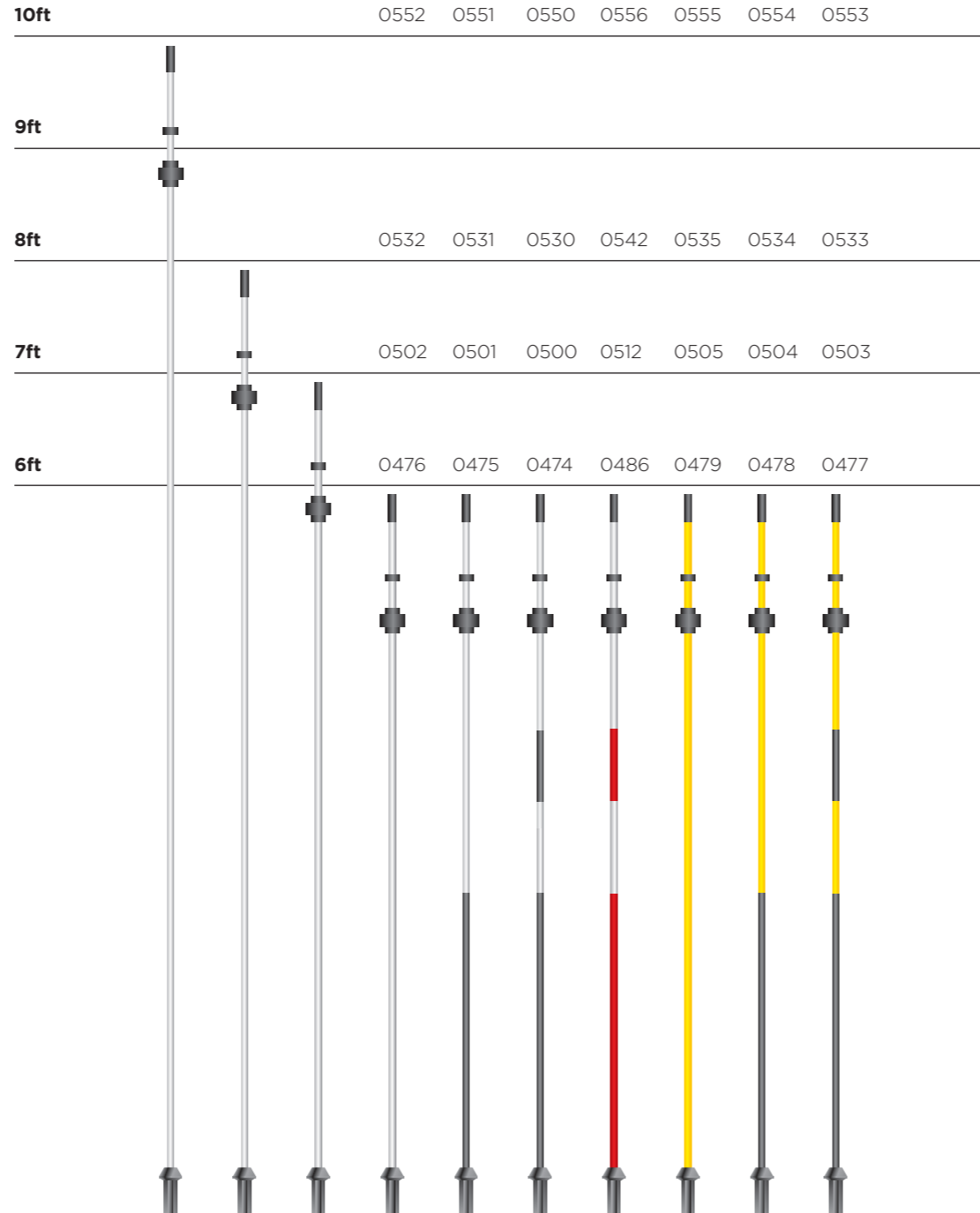

1/2" Winter Ferrule 0692



UK Nylon Ferrule 0679



UK Aluminium Ferrule 0682



1/2" Top 0677



1/2" Top Collar 0678



1/2" Swivel 0676



STANDARD PINS



USA Nylon Ferrule
0680

USA Aluminium Ferrule
0681

Turret Nut
0895

Threaded USA Flagpin Top
0896



10ft	0893	0892	0891	0894	0890	0889	0888		
9ft									
8ft	0879	0880	0881	0886	0876	0877	0878		
7ft	0849	0850	0851	0856	0846	0847	0848		
6ft	0819	0820	0821	0826	0816	0817	0818		

TACIT'S UK SWIVEL TOUR FLAGSTICK

For velcro or tie-on flags the Tacit flagstick lasts longer because of the simple design of the flagstick and holecup which eliminates the problem of excessive wear and leaning flagsticks. A pattern of splines on the underside of Tacit's anti-wear ferrule stops the stick from rotating and prevents excessive wear while the flag, which is attached to the swivel top of the flagstick, flows freely. The flagstick will accept any type of tie-on flag and is particularly suited to Tacit's neat and convenient clip-on velcro flag.

N.B. Tour Flagsticks come complete with aluminium ferrules as standard

WINTER FERRULE

No more poles blowing out, with this 6" long winter ferrule, designed to fit the Tacit 1/2" or 5/8" diameter flagstick. Combined with Tacit's 'lockon system' this ferrule is the perfect addition for winter conditions or links courses.

For 10ft flagsticks we recommend a Tacit "Extreme" Flagstick fitted with a winter ferrule. **see above**

TACIT'S USA SPECIFICATION FLAGSTICK

For tube flags, Tacit can now offer their latest range of high visibility American style flagsticks with tube flags. The high visibility flagstick is also longer lasting due to the splines on the underside of Tacit's Lockon antiwear ferrule. When used in conjunction with Tacit holecups, the specially designed ferrule locks into place and prevents the flagstick from rotating preventing excessive wear. Comes complete with USA Ferrule and Turret Nut.

N.B. Florida Flagsticks come complete with aluminium ferrules as standard

- UK Nylon Ferrule **0679**
- UK Aluminium Ferrule **0682**
- Winter Ferrule **0692**
- 1/2" Top **0677**
- 1/2" Top Collar **0678**
- 1/2" Swivel **0676**

* For fully sleeved flagsticks quote:- code + suffix S
i.e 6ft red and white sleeved = 0486S

- 5/8" Winter Ferrule **0691**
- 1/2" Winter Ferrule **0692**

- 0680**
- 0681**
- 0895**
- 0896**

- USA Nylon Ferrule
- USA Aluminium Ferrule
- Turret Nut
- Threaded USA Flagpin Top

* For fully sleeved flagsticks quote:- code + suffix S
i.e 6ft yellow sleeved = 0821S

“The Tour flagsticks Tacit produce are hard wearing and their double sided embroidered flags give a real professional finish”

Steve Robinson, Course Manager
Moortown Golf Club

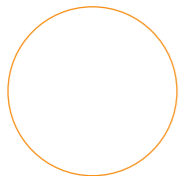

TACIT TOURNAMENT (JAVELIN) FLAGSTICKS

10ft

9ft

TACIT TOURNAMENT (JAVELIN) FLAGSTICKS

MACHRIHANISH DUNES TOURNAMENT (JAVELIN) FLAGSTICKS

8ft

0668W 0668R 0669 0669Y 0669YBB 0668 0669YBS 0658W 0658Y

7ft

0660 0667 0661 0662 0663 0664 0665 0671W 0674 0671WBB 0671Y 0674YBB 0671 0671YBS 0656W 0656Y

6ft

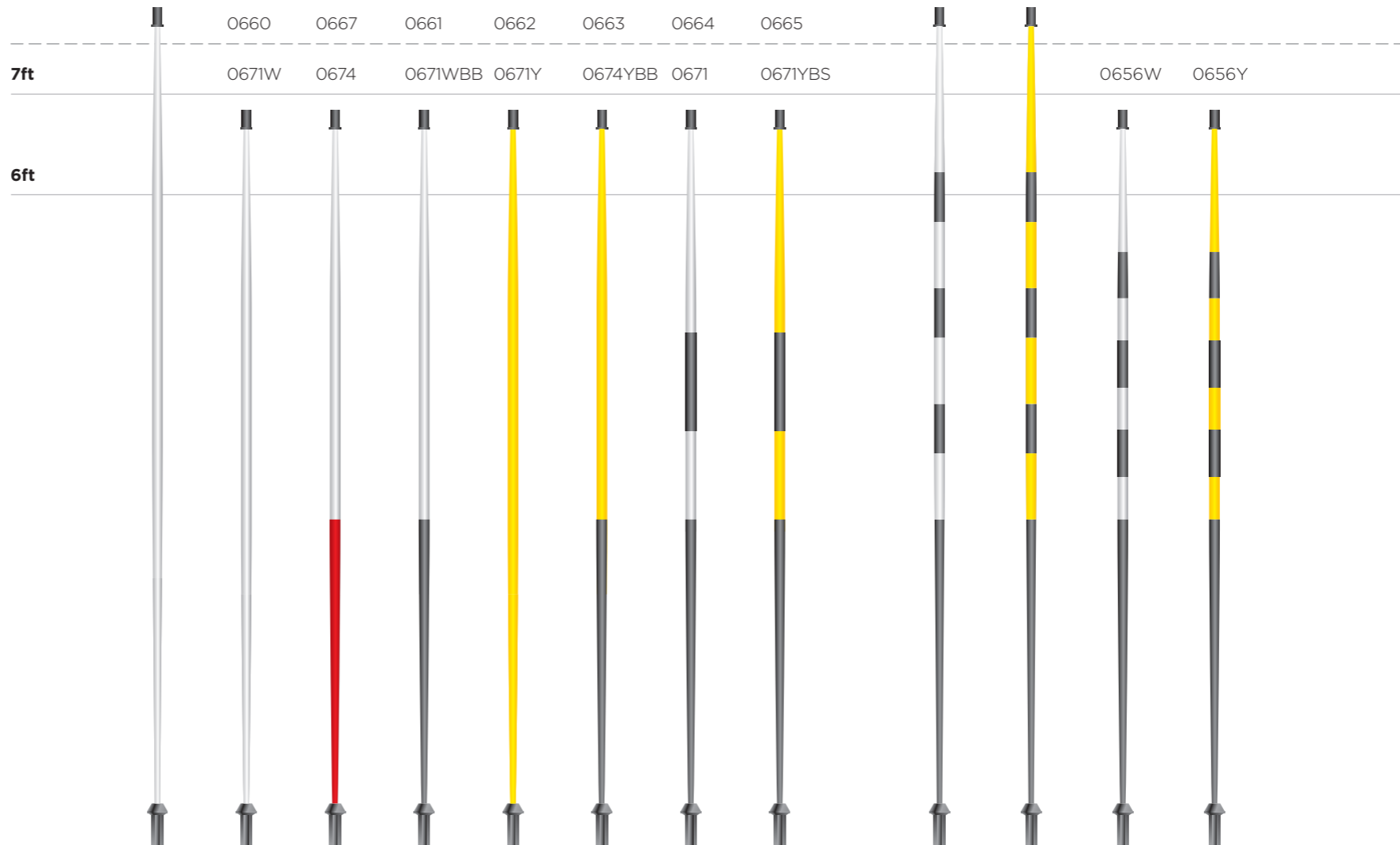

10ft

0643 0640

9ft

**MAC DUNES EXTREME
FLAGSTICKS**

**TACIT'S TRADITIONAL
RED TOP FLAGSTICK**

**TACIT'S EXTREME
FLAGSTICKS**

8ft

0558Y 0558W

0468

0623 0620

7ft

0557Y 0557W

0467

0593 0590

6ft

0466

0563 0560

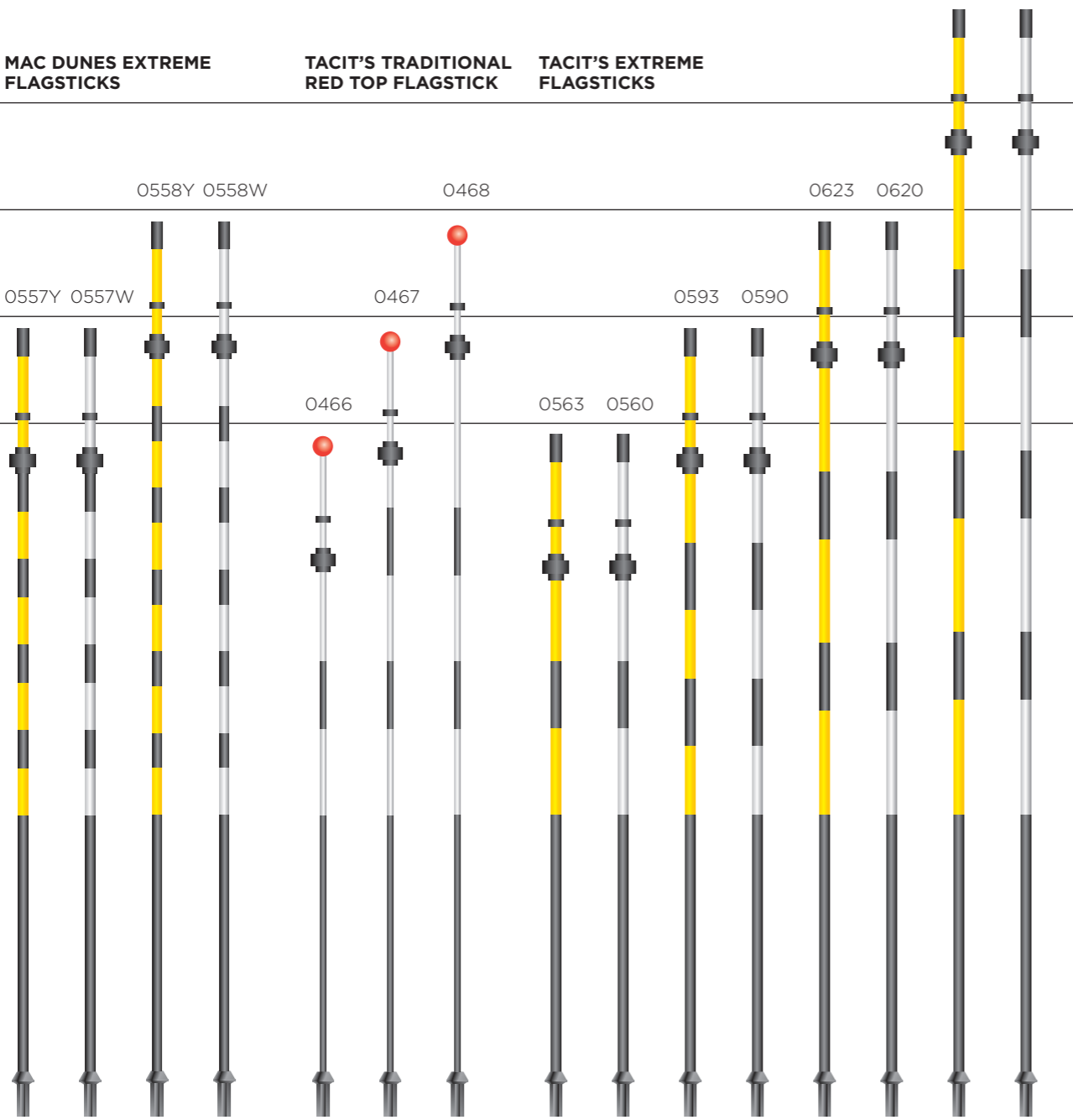

TACIT TOURNAMENT (JAVELIN) FLAGSTICKS

TACIT TOURNAMENT (JAVELIN) FLAGSTICKS

Improve the visibility of your flagsticks with Tacit's ultra visible Tournament (Javelin) Flagstick. Standing straight and tall at 7ft, 7'6", and 8ft Tacit Tournament (Javelin) Flagstick is tapered from 19mm in the centre to 13mm at either end. Made from solid colour impregnated composite material and then covered with our highly visible sleeving this is truly the champion of flagsticks. All Tacit flagsticks come complete with Tacit's unique anti-stick, anti swivel ferrule which results in reduced sticking, reduced ferrule and holecup wear and consequently upright flagsticks lasting longer than all the rest.

* All Tacit's Flagsticks meet GCSA and R & A specifications

The Machrihanish Dunes flagsticks have been developed in conjunction with The Machrihanish Dunes Golf Club in order to create a stiffer flagstick (more wind resistant) that is highly visible in the unique conditions that make up the British coastline.

TACIT'S TRADITIONAL RED TOP FLAGSTICK

Supplied in high visibility black & white stripe Tacit's Red Top Flagstick comes in your choice of sizes from 6ft to 8ft. The perfect budget range flagstick for discerning greenkeepers who like a good price without compromising quality. Sold in packs of 10.

TACIT'S EXTREME FLAGSTICK

Exclusive to Tacit; a more rigid 5/8" diameter flagstick especially designed for very windy courses. Has the same swivel action as our famous tour flagstick. Available in all colours complete with UK or USA anti-wear ferrule.

- Ultra high visibility coating
- Please ask to adjust stripes
- The top swivels but the bottom doesn't
- 8ft Version available by special request

8' Red Top Flagstick
7' Red Top Flagstick
6' Red Top Flagstick

0468
0467
0466

10' Tacit Extreme Flagstick Black & White UK
8' Tacit Extreme Flagstick Black & White UK
7' Tacit Extreme Flagstick Black & White UK
6' Tacit Extreme Flagstick Black & White UK

0640
0620
0590
0560

“The best performing wind flagstick I have ever used”

Simon Freeman, Course Manager
Machrihanish Dunes

TACIT STOP HOLECUP SYSTEM

Twenty years ago Tacit developed an Anti Swivel Ferrule / Holecup combination that has now been adopted by the majority of courses throughout Great Britain and Ireland. Indeed it is so good that some of the competitors have attempted to take the idea and produce anti swivel systems of their own.

Tacit have now taken another leap forward with the introduction of the Sub Cap to the central Ferrule bore, thus reducing holecup sinkage and reducing substantially the amount the ferrule will wear.

How has Tacit achieved this? Imagine the ferrule on the bottom of flagstick to be a pebble in a stream. Imagine the holecup to be a rock pocket that has collected the pebble, as the pebble turns within the hole, both the pebble wears smaller, whilst the hole wears bigger. How to stop the wear? Simple, stop the movement.

This is where the splines on the underside of Tacit's ferrule come into their own. Although unobtrusive, the splines instantly locate in the corresponding holes in the holecup and stop the flagstick from rotating within the holecup. Instead of the flagpins needing

to be replaced annually, there is now a two year renew cycle. Adding Tacit's sub cap to this scenario could lead to a three or four year renew cycle, as the wear on the ferrule and holecup is slowed even more.

Without this excessive wear brought about by ferrule rotation, the flagstick stays upright longer, with the chances of the flagstick blowing out of the holecup in strong winds being substantially reduced.

Why add a Sub Cap? The only way flagsticks will blow out of the hole or wear excessively, is if the ferrule is not locating correctly in the hole. On a busy course, the flagstick is relocated every 10 to 15 minutes throughout the day; the holecup is constantly hammered deeper and deeper into the hole. Originally set to the R & A recommended 1" depth, the holecup can end up 2" below the surface after a few days, especially in U.S.G.A. specification sand greens. The Sub Cap increases the ambient surface area by over 300%, allowing the holecup to effectively float in the green. The ingress of soil up the middle of the holecup is completely stopped but the cup can still be bedded solidly into the root zone.

TACIT STOP HOLECUP

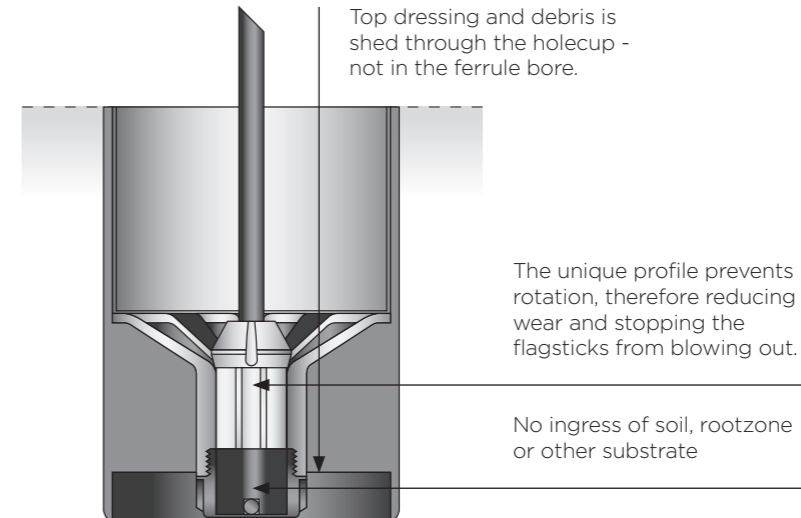
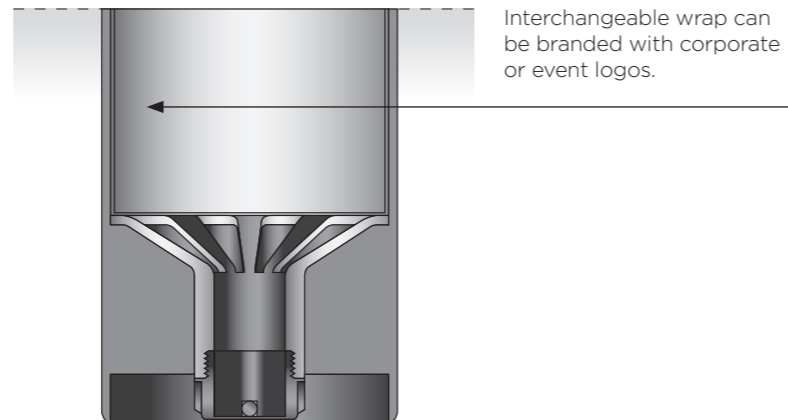

CARRY WASH BASKET
0898SS



6" HOLECUP COVER
0932



4 1/4" HOLECUP COVER
0931



HOLECUPS

TACIT STOP HOLECUP

Tacit's revolutionary new holecup brings to an end the ever sinking holecup. The sub cap on the underside increases the ambient surface area by 300%, stopping the holecup sinking below the R & A recommended 1" depth. The sub cap also stops rootzone from entering from the bottom of the holecup and up through the central ferrule socket allowing the ferrule on the base of your flagstick to locate itself perfectly every time.

- STOP Flagsticks blowing out
- STOP Holecups sinking
- STOP Ferrule wearing out
- STOP Flagsticks leaning over

HOLECUP COVERS

CARRY WASH BASKET

Designed to hold 10 cups at a time, the stainless steel construction of the basket allows dirty cups to be easily transported back to base, jet washed out and returned to the green without excessive handling.

Tacit 'STOP' Holecup White
Tacit 'STOP' Holecup Green
US Aluminium Holecup
UK Aluminium Holecup

0918
0918A
0899PL
0900A

6" Holecup Cover
4 1/4" Holecup Cover

0932
0931

Holecup Carry Jet Wash Basket

0898SS

“At St Andrews Links, we have found the Tacit holecups to be long lasting, especially the liners which are excellent. More importantly they stand up well to windy conditions and help the hole keep its shape”

Gordon Moir, Director of Greenkeeping
St Andrews Links Trust

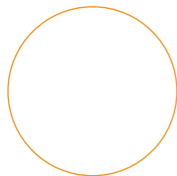

UK HOLECUPS

ABS
0900



ALUMINIUM
0900A



GREEN CUP
0900G



PUTTING
0986



WINTER
0902



HOLECUP INSERTS

Plain 0899S
(Pack of 20)



USA HOLECUPS

ABS
0918



ALUMINIUM
0899PL



GREEN CUP
0918A

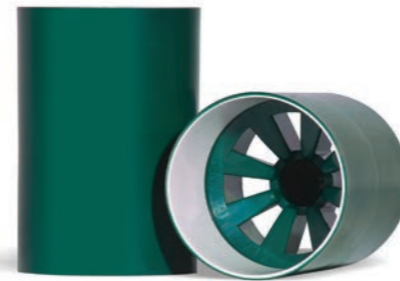

PUTTING
0985



WINTER
0903



HOLECUP INSERTS

Plain 0899S
(Pack of 20)



HOLECUPS

UK HOLECUPS

UK White Holecup
Aluminium STOP Holecup UK
UK Winter Holecup
UK Putting Cup
UK Green Holecup

0900
0900A
0902
0986
0900G

HOLECUP INSERT / WRAP

Aluminium Holecup 20 Sleeve Pack
Sub Cap for UK Aluminium Cup

0899S
0899CUK

USA HOLECUPS

USA White STOP Holecup
White Sub Cap (Pack of 10)
Aluminium STOP Holecup USA
USA Winter Holecup
USA Putting Cup
USA Green STOP Holecup
Green Sub Cap (Pack of 10)

0918
0920W
0899PL
0903
0985
0918A
0920G

HOLECUP INSERT / WRAP

Aluminium Holecup 20 Sleeve Pack
Sub Cap for USA Aluminium Cup

0899S
0899CUSA

“ Tacit Aluminum Holecups are top quality with a unique locking system. Using the Tacit sub cap means less wear on the ferrules and therefore no blow outs ”

Darrin Easingwood, Course Manager
Archerfield Links

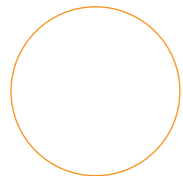

TACIT CT HOLECUTTER
0912



CT BLADES
0913



TACIT TURF REPAIRER - WINTER HOLECUTTER
0914



WINTER HOLECUTTER BLADES
0915



SHOLE HAMMER HOLECUTTER
1013BCOM



OUTSIDE SHARPENED
1013NON

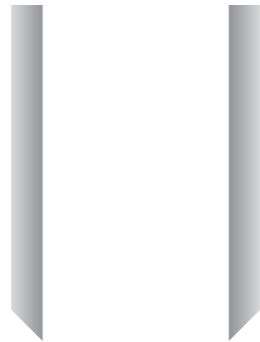

INSIDE SHARPENED
1013COM

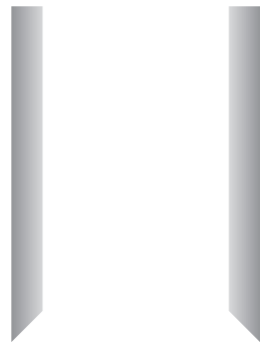

SHOLE SHOE
1013SHOE H



HOLECUTTING

TACIT TURF DOCTOR - WINTER HOLECUTTER

Designed and manufactured in the same way as Tacit's legendary Close Tolerance holecutter. Tacit's 150mm Turf Doctor removes turf quickly and effectively, leaving a perfect hole for either turf replacement or the setting of a winter holecup.

TURF DOCTOR REPLACEMENT BLADES

Tacit's heavy duty blades are made from high tensile steel and pressed into an exact shape before being case hardened and zinc plated.

TACIT CT HOLECUTTER

A legend in its own time, the Tacit CT Holecutter is relied upon by the P.G.A to cut exact holes for major events throughout Europe. Through the use of laser technology Tacit have manufactured the most accurate and durable holecutter on the market today. Incorporating adjustable handles for stability combined with a simple to use depth gauge and razor sharp case hardened steel blades Tacit's holecutter is the recognised market leader throughout Europe. Beware of imitations, insist on the original. * Cuts holes to USGA and R & A specifications.

CLOSE TOLERANCE BLADES (CT BLADES)

State of the art manufacturing systems have allowed Tacit's Holecutter to be made with blades so close they nearly touch, resulting in a perfect hole every time with no ripping or tearing where the blades meet.

SHOLE HAMMER HOLECUTTER

The Tacit Shole Holecutter cuts an exact 108mm hole every time with an integral hammer action. With an upright operation, it is easy on the back, with a unique effortless core extraction system. The whole unit weighs less than 10kg! The bullseye spirit level makes sure every hole is cut level. It also comes with easy interchangeable compression / non-compression blades with an optional adjustable depth gauge.

Tacit Turf Doctor

0914

Turf Doctor Blades (Pair)

0915

Heavy Duty Holecutter

0912

Heavy Duty Blade 15mm
Heavy Duty Blade 25mm

0913
0913M

Shole Holecutter with Compression Blade
Shole Holecutter with Non-Compression Blade
Non-Compression Blade
Compression Blade
Shole Shoe

1013BCOM
1013BNON
1013NON
1013COM
1013SHOE H

“The original and still the best the CT Holecutter keeps going while many of its rivals crumple at the challenge”

Gareth Roberts, Course Manager
Hankley Common Golf Club

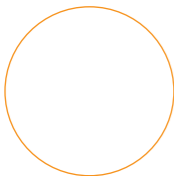

GREEN KEEPERS BUCKET
0937



HEAVY RUBBER
MALLET
0928



WATER BOTTLE
0939



GREENKEEPER
SCISSORS
0929



ALUMINIUM
SETTER 28MM
0925

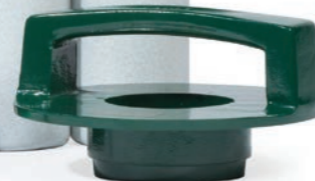

GRIPPER LIFTER
0959



LIFTER RAMMER
0926



SPRUNG LIFTER
0954



CUTTING BOARD

1013HG



RINGS

1013HGR



NANO GAUGE

0925NANO



ALUMINIUM SETTER 28MM

0925



NYLON SETTER 25MM

0925N



HOLECUTTING

TACIT HOLE CUTTING TOOLS

Hole Trimmer / Setter Aluminium	0925
Rubber Mallet	0928
Stainless Steel Cup Lifter / Rammer	0926
Hole Trimming Scissors	0929
Water Bottle	0939
Gripper Twin Handle Hole Cup Lifter	0959
Sprung Hole Cup Lifter	0954

GREENKEEPERS BUCKET

The Greenkeepers' bucket gives Greenkeepers the ideal place to store all the tools required for hole cutting. Easily carried out onto the green and with no sharp edges to damage or mark the green; the required tools are always handy and together. The central area can also be used for storing seed and top dressing for any emergency repairs.

0937

HOLECUTTING BOARD WITH DEPTH GAUGE

So simple its brilliant. Interlocking rings are attached to the holecutting board to give the depth of cut required. No guess work, every hole is cut exactly to the set depth, no more sunken or scalped old holes no matter which member of staff is cutting the holes.

Board	1013HG
Rings Pack (3 Rings)	1013HGR
10mm Shim Per Ring	

SETTER FINISHER

Traditional Cast Aluminium	0925
Lightweight Nylon	0925N

NANO GAUGE

A lightweight, pocket sized, hole gauge for use prior to and during tournaments for setting the cup and also assuring the hole is always the correct shape and size.

0925NANO

Machined to an exact 108mm diameter and 25mm in depth, from a solid aluminium block the hand gauge can instantly be used to correct the size and shape of the hole.

As used by referees at major tour events.

“ Tacit’s Nano Gauge is a precision tool which has been an invaluable help at re-setting damaged holes to the exact size during our event. It’s lightweight and fits easily into my pocket ”

James Crampton,
Director Of Championship
England Golf

BUNKER STONE RAKE
0167



16P LONG CURVED
6001L



16P SHORT CURVED
6001S



MAINTENANCE RAKES



MAINTENANCE RAKE
0157



WOODEN HAY RAKE
6007



16P LONG
6001SL



16P SHORT
6001SS

BUNKER STONE RAKE

A finer mesh allows the stainless steel to remove objects from the bunker not less than 5mm in diameter, collecting them for easy removal into a bin. The unique teeth on the underside of the rake break the surface and allow debris to be easily collected from the bunker.

16P LONG TOOTH - A CLASSIC

16P SHORT TOOTH

Modified specifically for bunker maintenance; the short teeth will not penetrate bunker linings nor will they go deeper than the PGA tournament recommended depth of 1".

MAINTENANCE RAKE

Makes short work of even the largest bunkers. Long teeth break up the sand while the short teeth collect any surface debris. Ideal for moving large amounts of sand towards the front of the bunker and on the face. Also ideal for clearing and collecting organic debris.

WOODEN HAY RAKE

16P LONG TOOTH CURVED

Designed specifically for the rounded edges of bunkers, this slant on the original classic gives a much better finish to all bunkers.

16P SHORT TOOTH CURVED

Created for the maintenance of pot bunkers this rake will only penetrate the PGA Tournament recommended 1" depth whilst being able to get into all those fiddly little round edges.

Bunker Stone Rake

0167

16p Long Tooth - Straight

6001SL

16p Short Tooth - Straight

6001SS

Maintenance Rake

0157

Wooden Hay Rake

6007

16p Long Tooth-Curved

6001L

16p Short Tooth-Curved

6001S

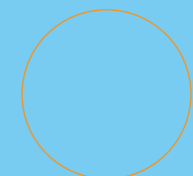

“The Tacit 16P Rake is useful for many different tasks, but is especially good for raking damp and wet bunkers giving a great finish when compared to other rakes”

Jamie Brooks, Head Greenkeeper
The Belfry

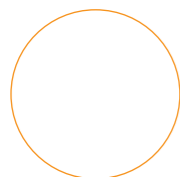

OPEN CORER
1018



EDGING KNIFE
6029

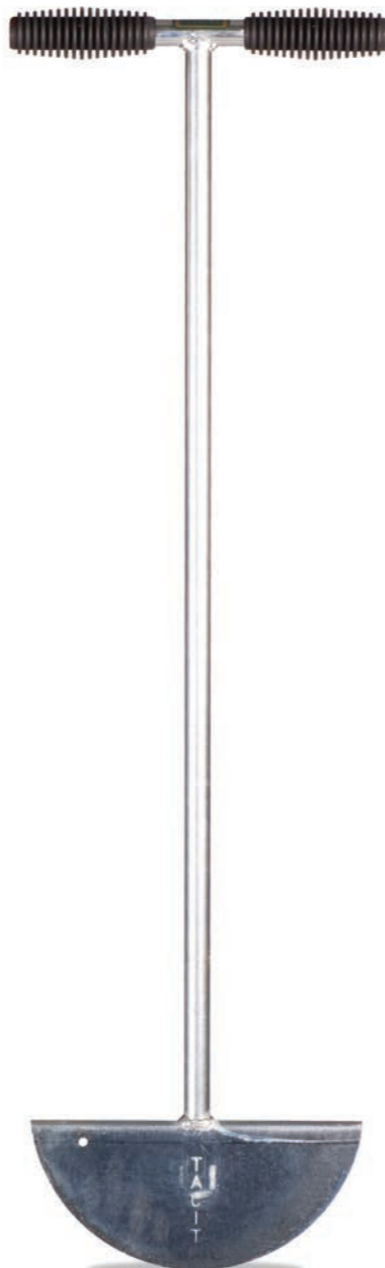

3½" SPRINKLER HEAD TRIMMER
1000



SOIL PROFILER
1017



FINE TURF TOOLS

LAWN LEVELLER
1015

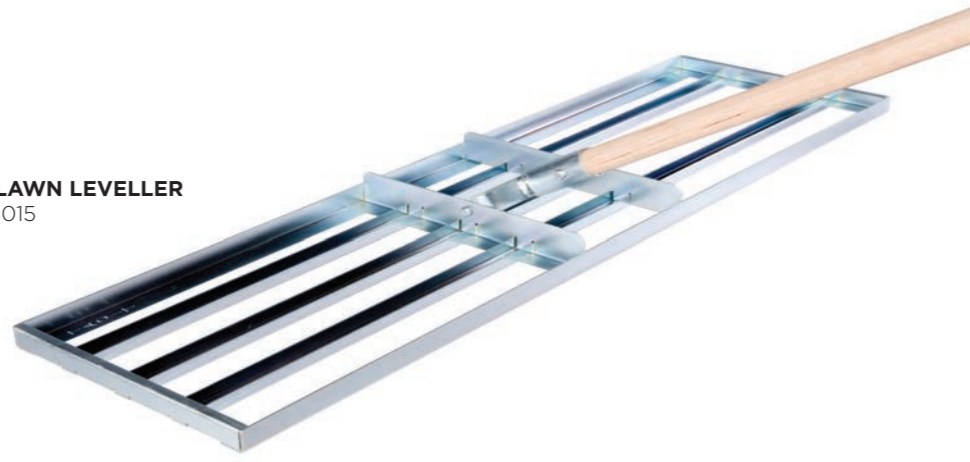

DRAG MAT
1038

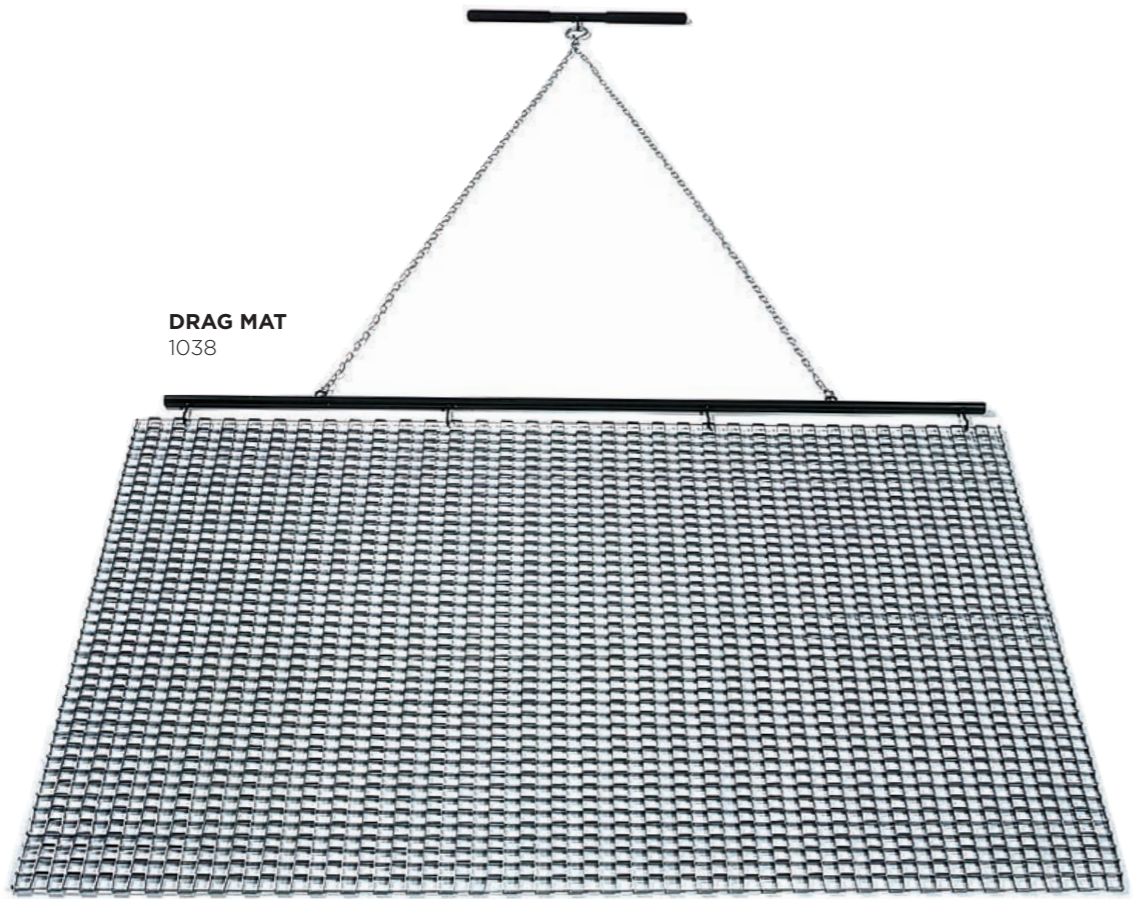

OPEN CORER (AGRONOMIST KNIFE)

S.T.R.I. recommended. Graded at 50mm points along the shaft to identify the depth of the sample. Moisture and compaction can be assessed without the hindrance of an end loop. Light and easy to carry. Stainless steel construction will last a life time.

EDGING KNIFE

Extra heavy duty professional one piece edging knife.

SPRINKLER HEAD TRIMMER - 3.5 INCH

Lightweight but robust. All trimmers come with case hardened blades. The 3.5 inch unit comes complete with its own handle.

SOIL PROFILER

S.T.R.I. recommended. The professional's choice for sampling root zone characteristics. Razor sharp blades cut a sample 200mm x 85mm x 18mm. The sample is easily removed for inspection and just as easily replaced in the same hole. Due to Tacit's unique hinged flap there are no separate parts to lose. Comes oven painted in burgundy.

LAWN LEVELLER (LUTE)

Tacit's Lawn Leveller (lute) is manufactured specifically for use on fine turf areas. The Lawn Leveller is ideal for spreading and grading a variety of sands and top dressings providing a super flat fine surface.

DRAG MAT

2m Drag Mat comes complete with draw bar and chains.

Open Corer	1018
Edging Knife	6029
Complete Unit - Size 3.5"	1000
Soil Profiler	1017
Lawn Leveller	1015
Drag Mat	1038

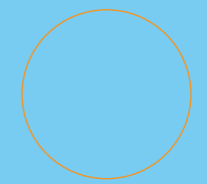

“With Tacit you can see the difference in quality straight away, from the embroidered flags with quality stitching to aluminium holecups with changeable sleeves to a top class flagstick to give me the presentation you want from course furniture”

Paul Fitzgerald, Course Superintendent
Castle Golf Club

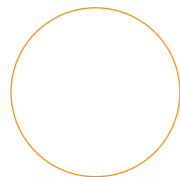

SPIKER
1040

SLOTTER
1039

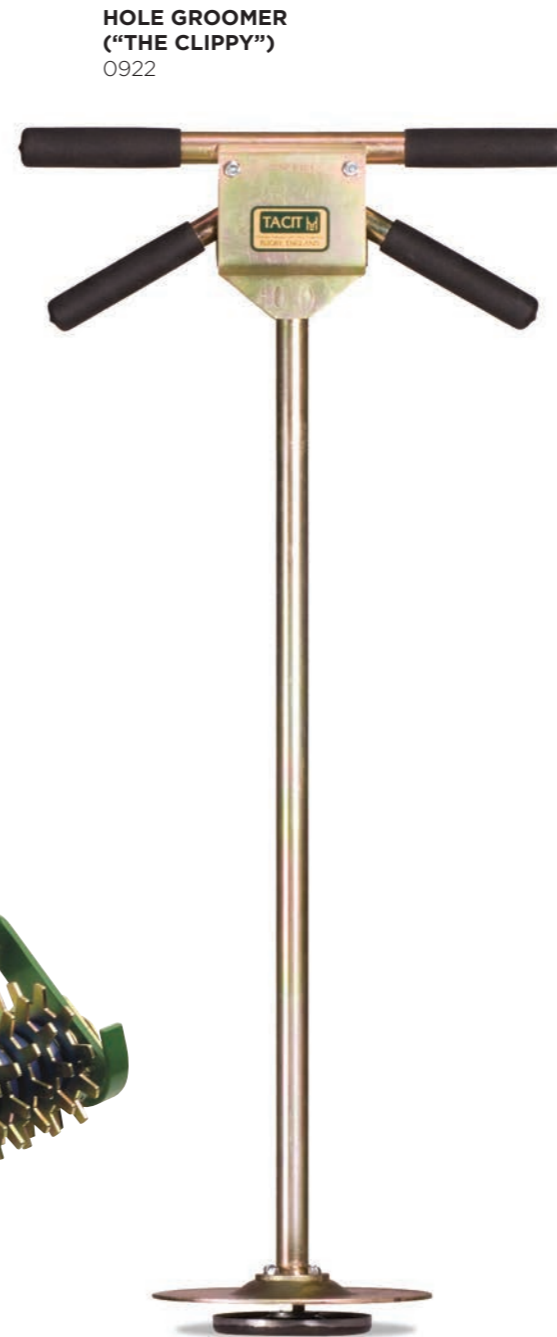

HOLE GROOMER
 (“THE CLIPPY”)
0922



REJUVENATOR
6040

REJOINER

After extensive research Tacit has yet again come up with a totally new and innovative idea to solve an age old problem of repairing damaged turf on the green.

The rejoinder allows the Greenkeeper to remove damaged, diseased or dead turf from the green and be replaced with an exact fit from the nursery green or from an area on the edge of the green that is less likely to be "in play".

The uniqueness of the Rejoinder comes in the shape of the super sharp cutting head. It is well known that grass does not grow in straight lines, consequently, the shape of the cutting head has no straight lines. This allows the new sod to knit much faster to the surrounding turf.

Combining this with a shape that not only locks itself in place when used individually but with contoured edges to lock into place no matter how much area needs to be covered; as a result the fine roots put out by the new sod are allowed to penetrate the surrounding soil and not broken by the movement of the replaced sod when it experiences pedestrian traffic.

This locking of the sod in place also means the lateral surface creep of the grass is encouraged. The sod then becomes an integral part of the green in a much shorter time.

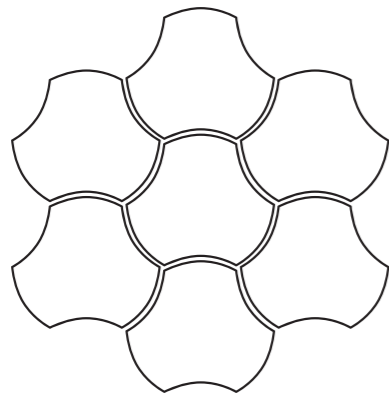

Example of the Rejoinder pattern.

0919J



FINE TURF TOOLS

HOLE GROOMER ("THE CLIPPY")

Use the NEW Tacit hole groomer and you can guarantee easy and consistent results every time. Manufactured to Tacit's exacting standards the hole groomer removes the time consuming process of hole top trimming. For a fantastic crisp finish that reinstates the hole to an exact 108mm in between cutting new holes. Using the Tacit hole groomer couldn't be simpler, simply place the device into the hole, pull up the handle, turn twice and remove. A perfect cut every time, in a fraction of the time. Perfect for reinstating the holes on the putting green. Bracket for mower attachment available.

REJUVENATOR

Restores ball marks, animal tracks and indentations in the green to the original putting surface level. No tamping needed, tailored for effective ergonomic use. Virtually no maintenance, stainless steel tines give your green the perfect finish.

REJOINER

Unique interlocking turf repair tool that allows damaged turf on the green to be repaired quickly and easily. The distinctive shape encourages the turf to knit in much quicker than other straight sided designs.

SEED SLOTTER

Specialist tool for overseeding worn areas etc on all fine turf areas. The rotary slotter unit will not tear up the surface and correct depth is obtained by the rotary stops at each end of the slotter reel. By providing a flat bottomed slot at the correct optimum depth of 1/2" (13mm approx), the seed 'turns' during the rapid germination period of less than 7 days. Moisture in the soil is more easily absorbed by the seed, encouraging stronger root growth, within a protected environment. Ideal for fescue germination.

SPIKER

A specialist agronomy tool the rotary spiker aids water / air penetration and stimulates root growth. Spikes made to a specific depth due to the rotary stops at each end of the spike reel. Can also be used to provide seed with a deeper germination depth when overseeding.

Hole Groomer
Replacement Blade
Replacement Plate

0922
0922B
0922BASE

6040

0919J

Seed Slotter

1039

Spiker

1040

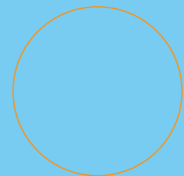

“The Clippy is a brilliant bit of kit that we use religiously when changing and refreshing holes”

Ian Willett, Course Manager
Thorpeness Golf Club

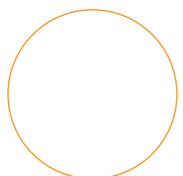

LOW PRESSURE SWITCH
1027

SWITCH TIP
1031

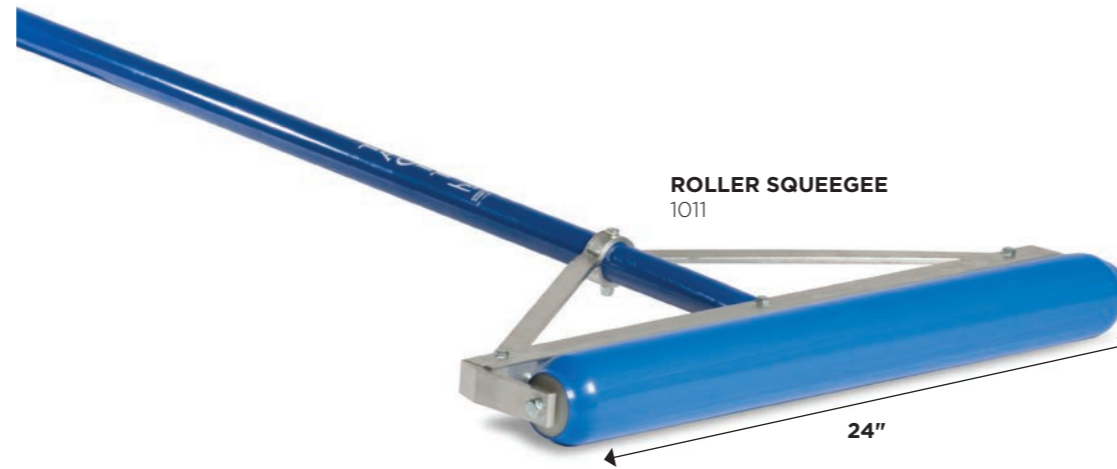

ROLLER SQUEEGEE
1011

24"

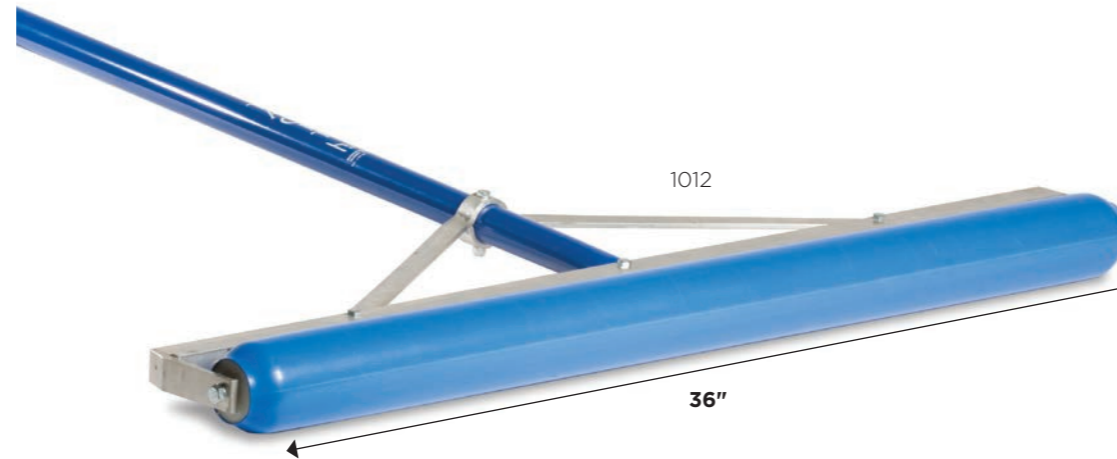

1012

36"

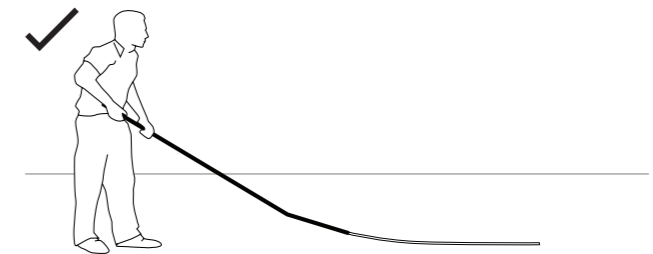
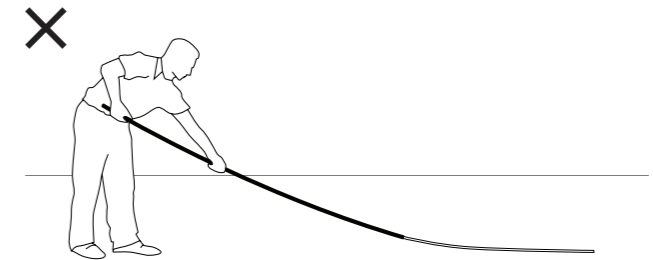

Take the hard work out of switching with Tacit's unique Low Pressure Curved Switch.

WATER / DEW REMOVAL

TACIT LOW PRESSURE SWITCH

Tacit's Low Pressure Switch is now the established standard in the industry. With its stiffer 8.5mm switch tip and its unique pull and lock fixing device, Tacit's Switch clears greens of dew quicker and more completely than any other switch on the market. An anodised aluminium shaft stays rust free whilst Tacit's soft grip provide a warm hold on the chilliest of days.

Low Pressure Switch with Tip
Replacement Switch Tip

1027
1031

ROLLER SQUEEGEE

Lightweight and robust, Tacit's Squeegee is the ideal tool for removing excess water from your greens without damaging the sward. A soft core allows for compression of the roller whilst the extra tough skin gives it protection and durability.

Roller Squeegee 24"
Roller Squeegee 36"

1011
1012

THE 2 IN 1 DEW BRUSH

Tacit produce 2 Dew Brushes for the discerning greenkeeper. The original Black 2.5m Dew Brush with soft bristles that glides easily over the green clearing dew with a squeegee action, whilst the newly developed Green 2m Dew Brush with stiff bristles flicks the dew into larger droplets forcing them to be absorbed by the soil. Both are light and easy to carry and both use Tacit's Switch as their handle.

Green Dew Brush-Complete
Green Dew Brush-Brush only
Black Dew Brush-Complete
Black Dew Brush-Brush only

1035
1036GB
1033
1034BB

STRAIGHT SWITCH HANDLE

Straight Switch Handle

1030

DEW BRUSH (HARD)
1035

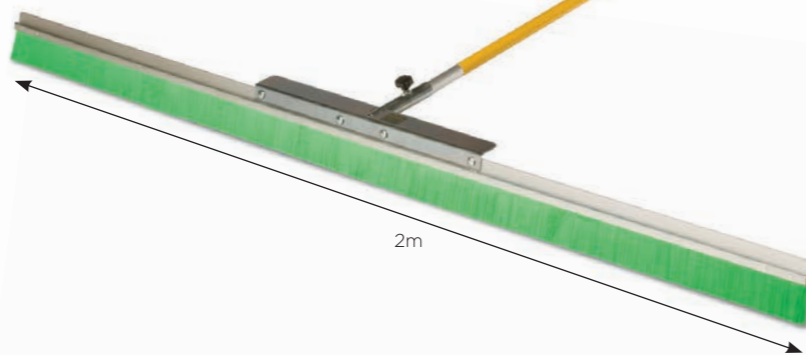

DEW BRUSH (SOFT)
1033

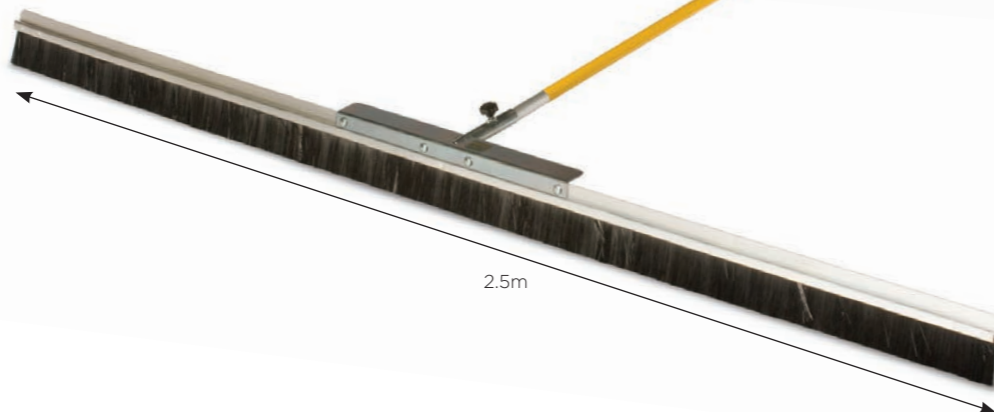

“The Low Pressure Switch is the preferred switch; robust, self cleaning and easy to use”

John Chantrell, Head Greenkeeper
Lilleshall Hall Golf Club



PUTTING MARKER

- 0948ALM
- 0984ALM
- 0964ALM
- 0952AL
- 0962ALM

ECONOMY PUTTING MARKER

- 0953N

RED BALL
0992



LOGO FLAG
0979L

STEM AND
BASE
09475B

BLACK BALL
0993



LOGO FLAG
0979L

STEM AND
BASE
09475B



STEM AND
BASE
0958

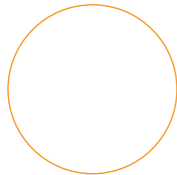

PUTTING GREEN

FLAG TYPE

Flags plain numbered or customised. Other colours available.

BACK SAVER TYPE

With your logo on one side and a choice of white, black or blue top with red numbers on a white background on the reverse.

ECONOMY PUTTING MARKER

HOLE STABILISING RINGS

CHIPPING PIN

CHIPPING FLAG

PUTTING CUPS

TACIT GREEN SPEED METER

Knowing your green speed is not just for the satisfaction of your captain, it will also allow you to consider the following:- effects of aeration, spiking and top dressing, mowers used, types & heights of cut, watering practices, double cutting, rollers, brushes, combs and a host of others. Try one and see.

P.S. And don't tell the club captain you bought it!

PUTTING GREEN ARROWS

Our Concorde Putting Green Arrows are numbered and cast from aluminium with a hardwearing powder coating.

	UK	USA
Red Plain Set of 9	0966	0966A
Red Numbered Set 1-9	0970	0970A
Yellow Plain Set of 9	0967	0967A
Yellow Numbered Set 1-9	0972	0972A
White Plain Set of 9	0968	0968A
White Numbered Set 1-9	0974	0974A
Blue Plain Set of 9	0969	0969A
Blue Numbered Set 1-9	0976	0976A
	UK	USA
White Numbered Set 1-9	0950	0950A
White Numbered Set 10-18	0951	0951A
Blue Numbered Set 1-9	0955	0955A
Blue Numbered Set 10-18	0956	0956A
Black Numbered Set 1-9	0960	0960A
Black Numbered Set 10-18	0961	0961A
Gold Numbered Set 1-9	0994	0994A
Gold Numbered Set 10-18	0995	0995A
Chrome Numbered Set 1-9	0996	0996A
Chrome Numbered Set 10-18	0997	0997A
White Top with Number Stem		0953N

Hole Stabilising Rings (Pack of 18)	0907
White / Black Base	4501
Plain	0983
Yellow	0983Y
Red	0983R
White	0983W
USA Putting Cup	0985
UK Putting Cup	0986
Tacit Green Speed Meter	1022
Putting Green Arrows Set 1-9	0990
Putting Green Arrows Set 10-18	0991

23

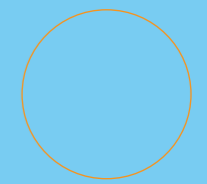

CHIPPING FLAG
0983Y



PUTTING CUPS

UK
0986

USA
0985



CHIPPING PIN
4501



HOLE STABILISING RINGS
0907



GREEN SPEED METER
1022



PUTTING GREEN ARROW
0990



0990L



“The Putting Markers fit well into the cup, with interchangeable top systems allowing us to customise for visiting groups using flag or marker style”

John Stanley, Greenkeeper
Eastham Lodge Golf Club

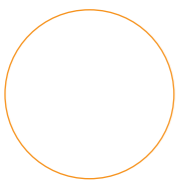

GROUND SOCKET TOOL
0199T



SOCKETS
0199

WHITE CHAIN
0114



GREEN CHAIN
0112



WITH SPIKE 0109G 0109W
WITHOUT SPIKE 0109GNS 0109WNS



BARRIER HOOP COVER
4950CGKAW

SEE PAGE 53



BARRIER HOOP
0118

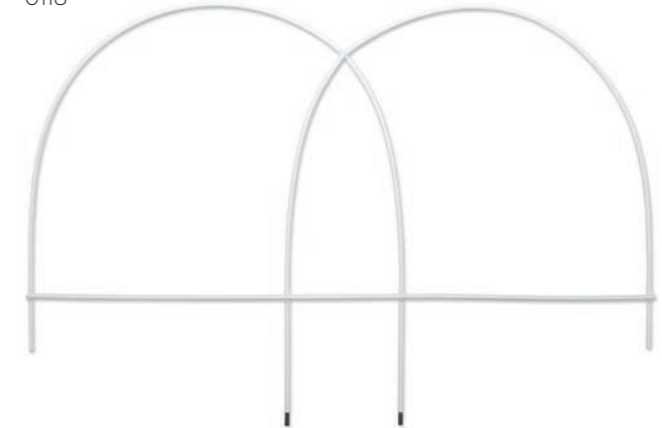

CHAIN HOOK
0109HOOK

TURF PAINT APPLICATOR
1020



T. STRIP
0125

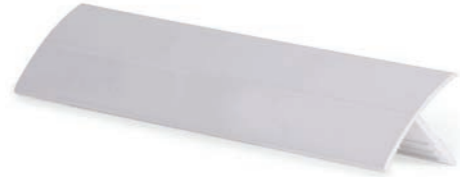

GREEN ROPE
0117



T.STRIP WITH WORDING
0125A



WHITE ROPE
0116



TURF PAINT

1021G 1021Y 1021 1021B 1021R



TRAFFIC CONTROL

RECONSTRUCTED PLASTIC FENCING POSTS

With stainless steel spike and slot to allow 6mm rope access

FENCING CHAIN

White chain 25m

Tacit chain is conveniently reeled on a 40m bulk roll. Available in white or green, our 8mm chain will stand the test of time.

CHAIN HOOK.

TACIT BARRIER HOOPS

An easy and cheap way of converting your barrier hoops to include large bold signage.

Made from knitted polyester and fixed in place with Velcro; barrier hoops can be put in place in seconds and due to the nature of the sign can easily be removed, washed and replaced to keep the temporary sign looking clean and fresh. Also available with your own personalised message.

TACIT BARRIER HOOPS COVERS

T. STRIPS 250MM LENGTHS

TURF PAINT

Xylene free Line Marker paint in an assortment of colours specifically designed and manufactured for use on specialist turf areas.

ROPE

Green rope with black and yellow flecks provides an obvious barrier whilst blending into the environment. Coiled for easy handling and convenience. 220m of 6mm line is wound on every reel.

Green with Spike
White with Spike
Green
White

0109G
0109W
0109GNS
0109WNS

Fencing Chain White 25m
Fencing Chain Green

0114
0112

0109HOOK

Barrier Hoop

0118

Please Repair Pitchmarks
Chemicals Applied
GUR
Spraying in Progress
No Trolleys
Trolleys →
Trolleys ←
Course Closed
Area Closed

4950PRP
4950CA
4950GUR
4950SIP
4950NT
4950TR
4950TL
4950CC
4950AC

T. Strips 250mm lengths
T. Strips 250mm lengths (with text)

0125
0125A

2 Wheel Line Marker
White Line Marker Paint
Red Line Marker Paint
Yellow Line Marker Paint
Blue Line Marker Paint

1020
1021
1021R
1021Y
1021B

Dark Green Rope Reeled
White Rope Coiled

0117
0116

“ Tacit linemarker paint is the best quality for getting the job done ”

Mark Campbell, Course Manager
Fortrose Rosemarkie Golf Club

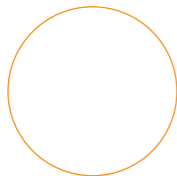

5240 	5241 	5242 	5243
5244 	5245 	5246 	5247
5248 	5249 	5250 	5251
5252 	5253 	5254 	5255
5256 	5257 	5258 	5259
5260 	5261 	5262 	5263
5264 			

* SPECIAL WORDING MADE TO ORDER

5201 	5202 	5203 	5204
5205 	5206 	5207 	5208
5209 	5210 	5211 	5212
5213 	5214 	5215 	5216
5217 	5218 	5219 	5220
5221 	5222 	5223 	5224
5227 			

SIGNS

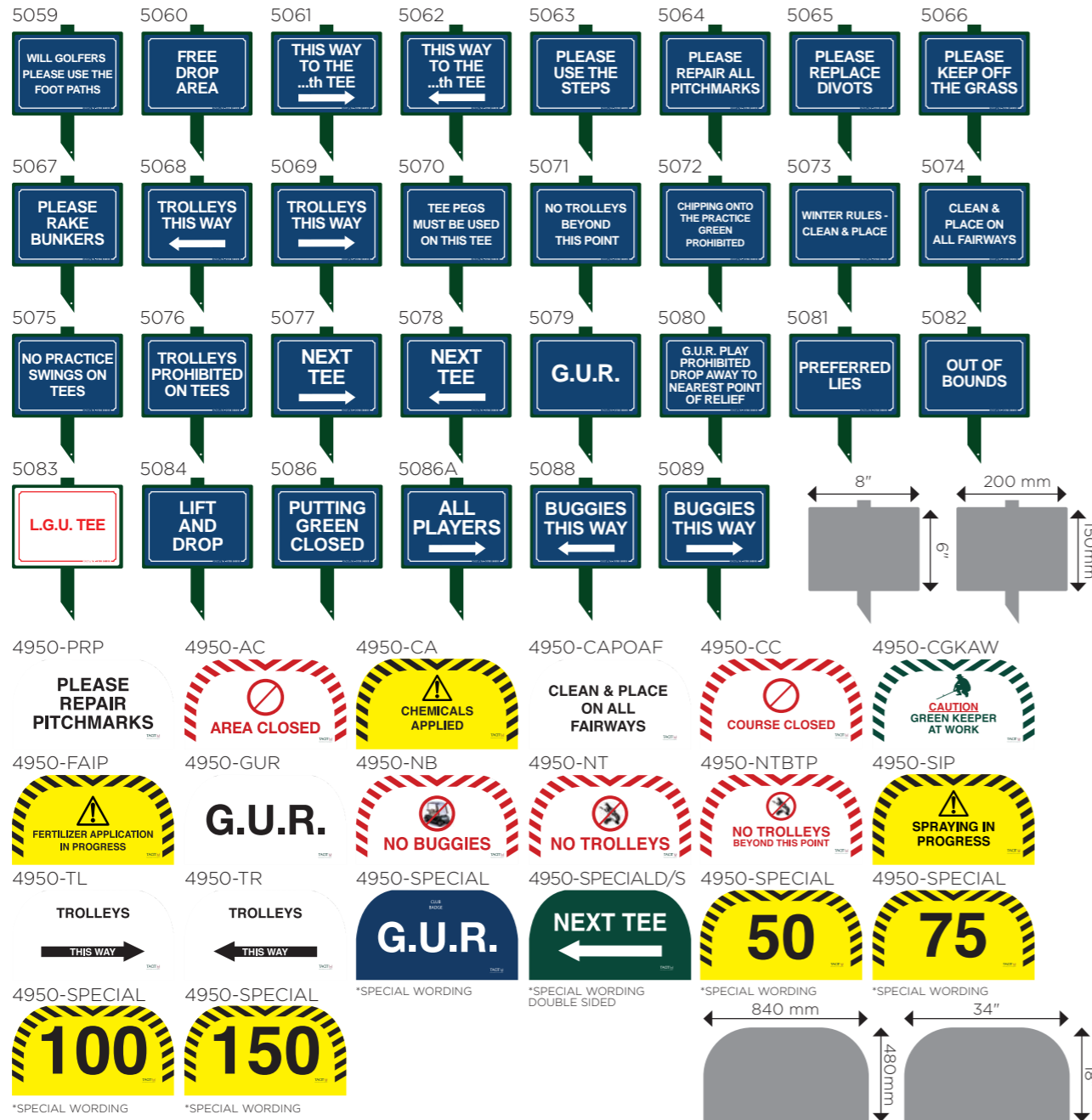

DOUBLE SIDED SIGNS
Two signs for the price of one!
Have visitors had problems finding their way around your golf course? Double sided directional and etiquette signs are the answer. Directional double sided signs do the work of two signs for the price of one, pointing golfers the right way no matter what their approach.

INFORMATION AND ETIQUETTE SIGNS
200mm x 150mm
Made from heavy gauge aluminium plate, hidden rivets and green stove painted for durability.

BARRIER HOOP SIGNS
An easy and cheap way of converting your barrier hoops to include large bold signage.
Made from knitted polyester and fixed in place with Velcro; barrier hoops can be put in place in seconds and due to the nature of the sign can easily be removed, washed and replaced to keep the temporary sign looking clean and fresh. Also available with your own personalised message.

200mm x 150mm

“Tacit’s Barrier Hoop & Barrier Hoop Cover are a good combination; discreet but do a job well”

Charles Edgar, Course Superintendent
Castle Rock Golf Club

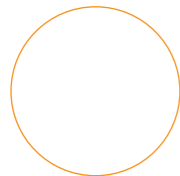

INFORMATION BOARDS DESIGNED BY CONSULTATION

5020 	5021 	5022 	5026 	5030 	5031 	5032 	5033 	5054
5034 	5035 	5036 	5037 	5038 	5039 	5040 	5041 	5023
5042 	5043 	5044 	5045 	5046 	5047 	5048 	5049 	
5050 	5051 	5052 	5053 	5057 	5058 	5017 	5056 	
5018 	5016 	5024 	5055 	5025 	5027 	5028 	5015 	

300mm
250mm
12"
10"

STANDARD SIZES

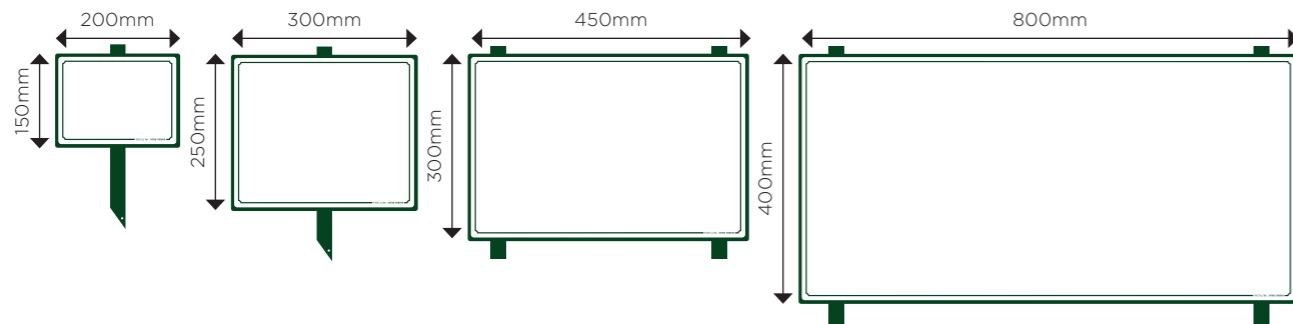

SPIKE 5114, PLATE 5115



SPIKE 5118, PLATE 5119



SPIKE 5130, PLATE 5131



SPIKE 5102, PLATE 5103



SPIKE 5120, PLATE 5121



SPIKE 5096S, PLATE 5096P



SPIKE 5097S, PLATE 5097P

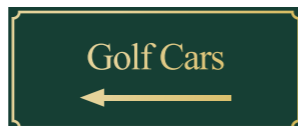

SPIKE 5104, PLATE 5105



SPIKE 5122, PLATE 5123



SPIKE 5098S, PLATE 5098P



SPIKE 5099S, PLATE 5099P



SPIKE 5106, PLATE 5107



(SPIKE) 5124, (PLATE) 5125



(SPIKE) 5116, (PLATE) 5117



(SPIKE) 5108, (PLATE) 5109



(SPIKE) 5126, PLATE 5127



SPIKE 5100, PLATE 5101



SPIKE 5110, PLATE 5111



SPIKE 5128, PLATE 5129



SPIKE 51112, PLATE 5113



OUR SPECIAL SIGNS ARE ONLY LIMITED BY YOUR IMAGINATION, ASK FOR DETAILS

SIGNS

GOLF COURSE SIGNS-300MM X 250MM

Made from heavy gauge aluminium plate complete with hidden rivets and stove printed for durability.

INFORMATION BOARDS

Design by consultation. See Page 9

TACIT SPECIAL SIGNS

Our range of Special Signs are available with or without a spike or ground socket fitting. Supply us with the message you want and we will do the rest.

A 150 x 200mm, B 250 x 300 mm, C 300 x 450 mm, D 400 x 800 mm.

CAR PARKING SIGNS - 300mm x 200mm

Made from heavy gauge aluminium plate complete with or without a spike.

SPECIALS & CORPORATE SIGNS

Using the latest technology Tacit's sign team are waiting to create signs specifically for your course. All signs can be custom made to any size and with any colour combination to suit your requirements. The inclusion of your club logo is our speciality. Call us now or speak to your area representative for more details or a sample.

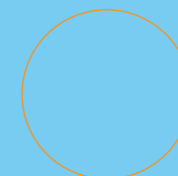

“The accuracy and efficiency of Tacit’s sign department means I have quality signs on the course at a moments notice”

Chris Gosdon, Head Greenkeeper
St Georges Hill Golf Club

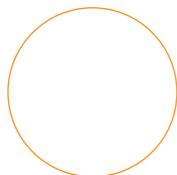

JANUARY

APRIL

JULY

FEBRUARY

MAY

AUGUST

MARCH

JUNE

SEPTEMBER

ORDER PLANNER

OCTOBER

NOVEMBER

DECEMBER

TACIT OUR PROUD
TO SUPPLY:



ENGLISH
GOLF UNION



SCOTTISH GOLF
UNION



59 Moat Farm Drive
Hillmorton
Rugby
Warwickshire
CV21 4HQ
England

www.tacitgolf.com

EMAIL: sales@tacitgolf.com

TEL: +44 (0)1788 568818

FAX: +44 (0)1788 537485

27

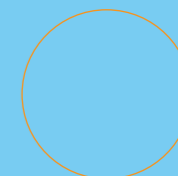

“I am impressed with the excellent fully stocked van service and due to the golf course being situated in a remote part of Scotland this is a great benefit to us, also there being no carriage cost for this facility is absolutely brilliant”

Bobby Mathieson, Head Greenkeeper
Machrihanish Golf Club

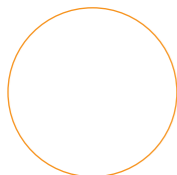
**PRICES**

Prices quoted in the price guide are correct at the time of going to press. Goods will be invoiced at prices ruling at the time of despatch.

SETTLEMENT

Strictly nett within 28 days of invoice. Interest will be charged on outstanding accounts at 2% above the current bank rates.

SMALL ORDER SURCHARGE

Orders under the value of £35.00 nett value excluding VAT will be subject to a surcharge of £5.00 together with carriage unless otherwise stated.

CANCELLATIONS

Goods returned after 30 days will only be accepted at Tacit's discretion and are subject to a 45% handling charge.

VALUE ADDED TAX

All prices are exclusive of VAT.

GOODS

On receipt these should be examined by consignee. When this cannot be done they must be 'unexamined'. If a clear signature is obtained for "Goods received in a good condition" no claim can be considered.

DAMAGED GOODS

Claims for damaged goods must be notified to the Company's head office by telephone or fax within three days of delivery. Written confirmation to be received by post within seven days of delivery. Claims notified after this period will NOT be entertained.

NON DELIVERY

Non delivery must be notified within five days of receipt of the invoice and confirmed in writing otherwise no liability will be considered.

LIMITED WARRANTY

Tacit warrants its products to be free from defects in materials and workmanship. Tacit's sole obligation under this warranty shall be to repair, replace or refund, to its buyer, the price of the defective product or component. All such repairs, refunds and replacements are subject to rules, terms and conditions that Tacit may promulgate from time to time.

DISCLAIMER OF OTHER WARRANTIES

The foregoing limited warranty is in lieu of all other warranties express or implied, including merchantability or fitness for a particular purpose. In no event shall Tacit be liable for indirect, consequential or special damages of any nature whatsoever.

TITLE OF GOODS

Title in the goods remains with the seller until full payment has been received by the company.

a) Should the buyer default in any payment when due, the seller will be entitled to repossess all the goods held by the buyer which are still the sellers property (without prejudice to any other right or remedy arising out of such default in payment) and for this purpose the seller will be entitled to enter upon the land or buildings on or which the goods may be situated and to remove the same. All costs incurred by the seller in repossessing the goods shall be borne by the buyer.

b) Any goods so repossessed shall be sold and the proceeds of the sale set off against the amounts due to the seller by the buyer. Any balance remaining of the proceeds of sale shall be paid to the buyer. If the said proceeds of sale are not sufficient the buyer shall remain liable to pay to the seller the amount remaining due together with any interest accruing therein.

DEFINITIONS**THE SELLER:**

Refers to Tacit

THE BUYER:

The organisation/person purchasing the goods

Please note Tacit has a policy of continual improvement, therefore we have to advise that sizes, weights, measurements and colours shown in the catalogue are nominal only and changes to designs, specifications and equipment may occur at any time without notice and without incurring any obligations. The precise specification of any article will always be given, if requested, on application.

N.B: All photographs, company names, golf courses and logos appearing in this brochure are for illustration purposes only and do not infer endorsement.

